



Adjusting lighting levels in commercial buildings

Energy savings from institutional tuning

Conservation Applied Research & Development (CARD)
FINAL REPORT

Prepared for: Minnesota Department of Commerce,
Division of Energy Resources

Prepared by: Seventhwave



Prepared by:

Scott Schuetter
Jennifer Li
Melanie Lord

Seventhwave

749 University Row, Suite 320
Madison, WI, 53705
Phone: 608.210.7149
website: seventhwave.org
Project Contact: Scott Schuetter

© 2015 Seventhwave. All rights reserved.

Contract Number: 72743

Prepared for Minnesota Department of Commerce, Division of Energy Resources

Mike Rothman, Commissioner, Department of Commerce
Bill Grant, Deputy Commissioner, Department of Commerce, Division of Energy Resources
Mary Sue Lobenstein, Project Manager and CARD Program Administrator
651-539-1872
marysue.lobenstein@state.mn.us

ACKNOWLEDGEMENTS

This project was supported in part (or in whole) by a grant from the Minnesota Department of Commerce, Division of Energy Resources, through the Conservation Applied Research and Development (CARD) program, which is funded by Minnesota ratepayers.

Other Seventhwave staff who contributed to this project include Ben Auchter, Scott Hackel, David Abel and Jesse Perreault. Staff from Lutron Electronics and Encelium Technologies also generously assisted with both finding systems for study, as well as understanding how to adjust the lighting control systems themselves. The project also benefitted greatly from the time and effort of each of the building managers and engineers at the sites we studied, as well as the staff at Xcel Energy, WPPI Energy and Franklin Energy for providing feedback on programmatic considerations. Thank you to all who participated.

DISCLAIMER

This report does not necessarily represent the view(s), opinion(s), or position(s) of the Minnesota Department of Commerce (Commerce), its employees or the State of Minnesota (State). When applicable, the State will evaluate the results of this research for inclusion in Conservation Improvement Program (CIP) portfolios and communicate its recommendations in separate document(s).

Commerce, the State, its employees, contractors, subcontractors, project participants, the organizations listed herein, or any person on behalf of any of the organizations mentioned herein make no warranty, express or implied, with respect to the use of any information, apparatus, method, or process disclosed in this document. Furthermore, the aforementioned parties assume no liability for the information in this report with respect to the use of, or damages resulting from the use of, any information, apparatus, method, or process disclosed in this document; nor does any party represent that the use of this information will not infringe upon privately owned rights.

Abstract

The U.S. Energy Information Administration (EIA) estimates that lighting is responsible for approximately 38 percent of electrical energy consumption in commercial buildings nationwide (EIA a 2003) and that only one percent of commercial spaces have automated lighting control systems (EIA b 2003). When prorated by total floor space and census data, lighting accounts for up to seven billion kWh of annual electrical consumption in the state of Minnesota. With such a large footprint, energy efficiency measures involving lighting have long been a target of utility Conservation Improvement Programs (CIPs).

There is evidence of significant energy savings potential from task tuning (sometimes called institutional tuning or high-end trim) in commercial spaces because these spaces tend to be over lit. Task tuning uses a commissioning process and/or technology to adjust light levels to meet location- or task-specific lighting needs. A meta-study of energy savings from lighting controls suggests that task tuning has the potential to save 36 percent (Williams 2012) or more of lighting energy use.

We monitored lighting systems in 10 buildings in Minnesota and Wisconsin before implementing task tuning and after. The data collected is used to quantify the effect of task tuning in terms of energy, emissions and economics.

Table of Contents

| | |
|---|----|
| Abstract..... | i |
| List of Figures | iv |
| List of Tables | vi |
| Executive Summary (or Policy Brief as applicable) | 1 |
| Background and objective..... | 1 |
| Results..... | 1 |
| Measured savings results..... | 1 |
| Areas of greatest potential | 2 |
| Energy savings interactivity | 2 |
| Economics | 3 |
| Minnesota savings potential..... | 3 |
| Occupant comfort | 3 |
| Introduction | 4 |
| Background and objective..... | 4 |
| Literature review..... | 4 |
| Data Collection | 7 |
| Buildings studied | 7 |
| Data Acquisition Protocol..... | 11 |
| Methodology and Analysis..... | 12 |
| Lighting System Measurements..... | 12 |
| Lighting System Adjustment..... | 15 |
| Measured Energy Savings | 20 |
| Theoretical Energy Savings | 22 |
| Energy Savings Interactivity..... | 31 |
| Data Quality Control | 33 |
| Extrapolation Methodology..... | 34 |
| Results..... | 36 |
| Measured Energy Savings Results..... | 36 |
| Conference Room Case Study | 38 |
| Theoretical Energy Savings Results..... | 41 |
| Energy Savings Relationships | 46 |
| Level of Commissioning | 46 |

| | |
|---|----|
| Level of Lighting Design..... | 47 |
| Building Type | 48 |
| Photocontrol | 48 |
| Occupant Comfort | 49 |
| Energy Savings Interactivity Results..... | 50 |
| Correlation between Energy Savings and Percent Reduction..... | 52 |
| Economics of Task Tuning..... | 53 |
| Life Cycle Cost Analysis | 54 |
| Simple Payback Analysis | 55 |
| Minnesota Savings Potential | 56 |
| CIP Recommendations | 57 |
| Program Approaches..... | 59 |
| Outreach..... | 60 |
| Analysis and Training..... | 61 |
| Verification and Persistence | 62 |
| Cost Effectiveness | 63 |
| Best Practices and Lessons Learned | 63 |
| Future work | 68 |
| References | 69 |
| Appendix A: Occupant Survey and Results | 71 |
| Appendix B: Task Tuning Checklist..... | 73 |
| Appendix C: Building specific lessons learned | 82 |

List of Figures

| | |
|---|----|
| Figure 1. Distribution of measured tuning savings (by %) for the over lit spaces..... | 2 |
| Figure 2: Summary of buildings considered for study (N=18)..... | 8 |
| Figure 3: Summary of spaces considered for study (N=28)..... | 9 |
| Figure 4: Example lighting system's measured critical workplane illuminance versus power.... | 13 |
| Figure 5: Light meter measurement points for Regular Area with Single Row of Continuous Luminaires. | 14 |
| Figure 6: Monitored lighting power in a space without photocontrol over five days during period 1..... | 15 |
| Figure 7: Monitored lighting power in a space with photocontrol over five days during period 1. | 16 |
| Figure 8: Percentage that a space was over lit or under lit in comparison to the IESNA illuminance recommendations in descending order..... | 17 |
| Figure 9: Percentage that a space was over lit or under lit in comparison to the IESNA illuminance recommendations and occupant preferred illuminance levels that we were able to achieve. | 19 |
| Figure 10: Average hourly lighting power both before and after tuning. | 20 |
| Figure 11: Untuned lighting power for a system without photocontrol over a typical day. | 23 |
| Figure 12: Power and illuminance savings from task tuning without photocontrol. | 24 |
| Figure 13: Tuned and untuned lighting power for a system without photocontrol over a typical day..... | 25 |
| Figure 14: Tuned and untuned lighting power for a system with photocontrol over a typical day without approaching the system's minimum power..... | 26 |
| Figure 15: Example lighting system's power and illuminance savings from task tuning with photocontrol without approaching the system's minimum power..... | 27 |
| Figure 16: Tuned and untuned lighting power for a system with photocontrol over a typical day that does approach the system's minimum power. | 28 |
| Figure 17: Example lighting system's power and illuminance savings from task tuning with photocontrol that does approach the system's minimum power | 29 |
| Figure 18: Tuned and untuned lighting power for the same system both with and without photocontrol..... | 32 |
| Figure 19: Distribution of measured tuning savings (by %) for the sample of spaces..... | 37 |
| Figure 20: Distribution of measured tuning savings (by kWh/kW) for the sample of spaces. | 38 |
| Figure 21: Conference room and associated digital controller..... | 39 |

| | |
|---|----|
| Figure 22: Lighting power profile of conference room before tuning. | 39 |
| Figure 23: Lighting power profile of conference room after tuning. | 40 |
| Figure 24: Percent of time spent in a given power range both before and after tuning. | 41 |
| Figure 25: Distribution of theoretical tuning savings (by %) for the sample of spaces..... | 43 |
| Figure 26: Distribution of theoretical tuning savings (by kWh/kW) for the sample of spaces. ... | 44 |
| Figure 27: Theoretical versus measured energy savings (by kWh/kW)..... | 45 |
| Figure 28: Theoretical versus measured energy savings (by %). | 45 |
| Figure 29: Average theoretical energy savings (in kWh/kW) for varying commissioning approaches. | 46 |
| Figure 30: Average theoretical energy savings (in kWh/kW) for varying levels of lighting design..... | 47 |
| Figure 31: Average theoretical energy savings (in kWh/kW) for varying building types. | 48 |
| Figure 32: Average theoretical energy savings (in kWh/kW) for systems with or without photocontrol..... | 49 |
| Figure 33: Level of satisfaction with light level versus percentage reduction. | 50 |
| Figure 34: Energy savings (in kWh/kW) from task tuning a system with photocontrol and the same system had it not had photocontrol. | 52 |
| Figure 35 Theoretical energy savings (by %) versus percent reduction..... | 53 |

List of Tables

| | |
|---|----|
| Table 1: Strategies for reducing lighting energy use..... | 5 |
| Table 2: Monitored space characteristics | 10 |
| Table 3: Untuned and recommended average illuminance for each space | 16 |
| Table 4: Untuned, recommended and preferred average illuminance for each space that was adjusted to a level other than the IESNA recommendations..... | 18 |
| Table 5: Primary metrics describing the measured energy savings from tasking tuning. | 36 |
| Table 6: Range of savings for tuned spaces..... | 37 |
| Table 7: Primary metrics describing the theoretical energy savings from tasking tuning to recommended lighting levels. | 42 |
| Table 8: Primary metrics describing the theoretical energy savings from tasking tuning to preferred lighting levels. | 43 |
| Table 9: Measured and theoretical energy savings. | 44 |
| Table 10: Energy savings (in kWh/kW) from task tuning a system with photocontrol and the same system had it not had photocontrol. | 51 |
| Table 11. Economic inputs for life cycle cost analysis..... | 54 |
| Table 12. Break-even costs for task tuning of 1 kW of lighting. | 55 |
| Table 13. Potential savings from task tuning in Minnesota. | 57 |
| Table 14. Examples of Advanced Lighting Controls Programs | 58 |
| Table 15. Program Approaches for Advanced Lighting Controls | 59 |
| Table 16. Lessons learned from implementing task tuning | 66 |

Executive Summary (or Policy Brief as applicable)

Background and objective

Task tuning (sometimes called institutional tuning or high-end trim) is one form of lighting control that can be used in commercial buildings to save energy. It involves dimming lights in a space so that the average illuminance at the working plane is appropriate for the type of use in that space. Task tuning has the potential to save energy without decreasing occupant satisfaction because most commercial spaces, for a variety of reasons, are over lit. With more widespread adoption of dimmable ballasts and LED lighting there are more opportunities to apply this relatively simple-to-implement efficiency measure. However, because it is relatively new to the marketplace, it suffers from a lack of understanding on how to implement it and of verified energy savings to justify its cost.

In this study, we proposed to field test task tuning, verify the savings and document best practices to show how this process could be included in utility CIP offerings in Minnesota. If our hypothesis was correct and systems were indeed providing too much illumination, then building professionals should be able to adjust practices, modify specifications, and include commissioning guidelines for lighting systems – a practice that is not currently widespread. Efficiency programs in Minnesota could also use the results of the study to add task tuning as a new component of their lighting programs.

To that end, we collected sub-hourly measurements of illuminance and lighting power for 17 office, public assembly and education spaces in Minnesota and Wisconsin. For a subset of spaces, we tuned the lighting controls to provide the appropriate amount of light. For these spaces, we took measurements with the controls as they were found, and then repeated the measurements after the lighting controls had been tuned. By comparing the measured data from before and after tuning, we estimated the energy savings from task tuning. We also developed theoretical energy savings calculations to explore the greatest potential areas for task tuning savings, as well as the interactivity between task tuning and photocontrol. We further analyzed the economics of task tuning and the potential for savings for Minnesota. We compiled the qualitative information gathered during the study into best practice guidelines for achieving savings while maintaining high levels of occupant comfort, as well as recommendations for implementing task tuning within CIPs (see CIP Recommendations). Finally, we compiled a checklist for how to task tune (see Appendix B: Task Tuning Checklist) that serves as an outline for those interested in implementing task tuning themselves.

Results

Measured savings results

The measured data shows that the **average savings from task tuning was approximately 613 kWh for every kW of lighting that was dimmable, or about 22 percent of the dimmable lighting energy**. If we look at the units of kWh/kW, this essentially simplifies to the number of equivalent *hours* in a year for which the lights would be fully off. If a typical commercial space operates for 3,500 hours per year, it seems reasonable that task tuning could essentially keep the

lights off for nearly one-fifth of the time. On a per square foot basis, for a typical commercial space lit with 1 W/ft², this savings equates to 0.6 kWh/ft².

Savings ranged from as high as 36 percent or 1,662 kWh/kW of dimmable lighting in a highly over lit office with relatively long hours of operation, to as low as 5 percent or 136 kWh/kW of dimmable lighting in a computer lab with relatively short hours of operation and not strongly over lit. Figure 1 shows the distribution of energy savings across the measured spaces.

Figure 1. Distribution of measured tuning savings (by %) for the over lit spaces.

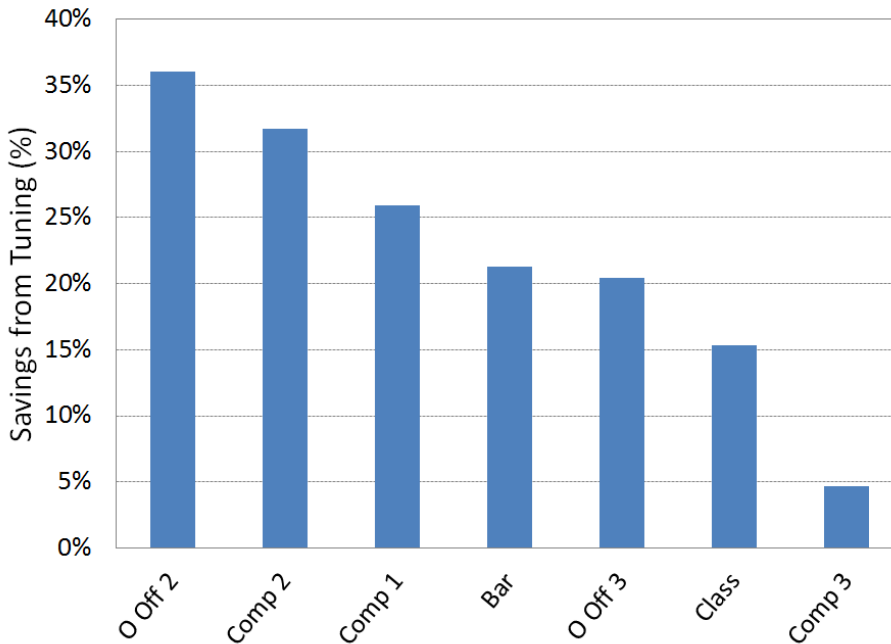

Areas of greatest potential

Our theoretical energy savings calculations highlighted the following characteristics that tended to correspond to high potential for task tuning savings:

1. A lighting system that had not been commissioned or was commissioned by the owner.
2. A lighting system that had been designed by a contractor as opposed to a lighting designer or electrical engineer.
3. A lighting system in an education, public assembly building or office.
4. A lighting system with dimming controlling significant electric power in spaces with longer hours of operation, such as open offices with photocontrol or LEDs. Dimmable systems for A/V equipment did not exhibit high levels of savings opportunity.

Energy savings interactivity

Our theoretical energy savings calculations show that the average savings from task tuning of systems with photocontrol are approximately 1,180 kWh for every kW of lighting that is dimmable. If the same systems had *not* had photocontrol the savings from tuning would increase to approximately 1,620 kWh/kW. Therefore, on average, photocontrol diminishes the

savings from task tuning by 440 kWh/kW or 27 percent. However, it should be noted that task tuning savings of systems with photocontrol remain relatively high, albeit lower than systems without photocontrol. Note that this reduction should not be applied to the measured savings estimates stated in this report, as the majority of those systems already had photocontrol.

Economics

In order to break even in terms of life cycle cost, owners can afford to spend up to \$750 per kilowatt of dimmable lighting for hardware and time associated with task tuning. This equates to about \$0.75 per square foot for a building with a lighting power density of 1.0 watt per square foot.

In terms of simple payback, the savings from task tuning are not sufficient to justify the incremental cost of purchasing a dimmable lighting system. This upgrade is more likely to be driven by other design requirements such as daylighting, controllability needs, or occupant satisfaction (eliminate the distraction of on/off switching). We therefore analyzed the payback from task tuning for a dimmable system without the equipment costs. In this situation, the only incremental cost is the time associated with tuning, which we estimated ranged from \$0.03 to \$0.06 per square foot, resulting in a simple payback of between 0.5 and 1.1 years. **Due to these short payback periods, we recommend that task tuning be implemented in new construction projects or major renovations in which a dimming system is already planned as part of the design requirements. For the same reason, if a dimming system already exists in a facility, task tuning should be strongly considered as a way to achieve cost-effective energy savings.**

Minnesota savings potential

In total, we estimate that task tuning could potentially save Minnesota 5,023 megawatthours annually, or the equivalent of 528 typical Minnesota household's annual electric consumption. This energy savings would reduce greenhouse gas emissions by 4,843 tons of carbon dioxide, or the equivalent of taking 1,020 passenger vehicles off the road for a year. This energy savings equates to over \$487,000 of annual cost savings.

Occupant comfort

Task tuning is essentially a tradeoff between energy consumption of a lighting system and light levels in a space. When performing task tuning, it is important to balance energy savings with occupant visual comfort, as tuning that is too aggressive may result in high energy savings at the expense of occupant satisfaction.

Complicating this balance is the fact that occupants perceive light levels differently both amongst individuals and under varying situations. Because of this complication, **we recommend that task tuning be conducted with occupant feedback in order to balance energy savings and occupant visual comfort.** Although this may result in lower immediate energy savings, it would increase energy savings persistence, as facility managers would be less likely to override tuned controls based on occupant complaints.

Introduction

Reductions in energy consumption from lighting historically have been achieved through improvements in luminaire efficiency, such as substituting T8 lamps for old T12 lamps or upgrading from fluorescent fixtures to LEDs. These technologies produce the same light output with less energy usage. Because of recent code changes and maturation of the lighting retrofit market, lighting efficiency program managers as well as the lighting industry are focusing more attention on effective lighting controls rather than luminaire upgrades. Lighting controls are designed to deliver the right amount of light at the time it is needed.

Task tuning is one form of lighting control that can be used in commercial buildings to save energy. It involves dimming lights in a space so that the average illuminance at the working plane is appropriate for the type of use in that space. The working plane is the height at which the task is conducted—for example, for desk work in the U.S. the working plane is 30 inches above the floor. Task tuning has the potential to save energy without decreasing occupant satisfaction because most commercial spaces, for a variety of reasons, are over lit. With more widespread adoption of dimmable ballasts and LED lighting there are more opportunities to apply this relatively simple-to-implement efficiency measure. However, because it is relatively new to the marketplace, it suffers from a lack of understanding on how to implement it and of verified energy savings to justify its cost.

Background and objective

We calculate that lighting accounts for up to seven billion kWh of annual electrical consumption in Minnesota based on information from the U.S. Energy Information Administration and prorated by total commercial floor space and census data for the state. Given the evidence for significant savings that emerged from a literature review (36 to 60 percent for office and retail space respectively) we proposed to field test task tuning, verify the savings and document best practices to show how this process could be included in utility CIP offerings in Minnesota.

Literature review

We conducted a literature search to establish a foundation for our project and to help inform our approach and economic analysis. We concluded from our review of the current literature that task tuning has the potential for significant savings, that it is relatively easy to implement but needs to be more widely understood and incorporated into lighting efficiency programs with incentives to overcome cost barriers. Following is an annotated bibliography of the literature we reviewed.

Lighting Controls in Commercial Buildings by Alison Williams et al. Published in *Leukos*, volume 8, number 3, January 2012.

The authors conducted a Meta study of research on energy savings from lighting controls in commercial buildings. From the 88 papers they reviewed (40 published in peer-reviewed journals or presented at conferences and 48 self-published reports or case studies) they identified four control strategies and summarized energy savings for each of those strategies.

The four strategies for reducing electric lighting energy use and their respective savings are shown in Table 1.

Table 1: Strategies for reducing lighting energy use

| Control strategy | Definition | Technologies used | Potential savings |
|------------------|---|--------------------------------|-------------------|
| Occupancy | Adjusting light levels based on the presence of people | Occupancy sensors, time clocks | 24% |
| Daylighting | Adjusting light levels based on the amount of natural light | Photosensors, time clocks | 28% |
| Personal tuning | Allowing individuals to adjust light levels in their space | Dimmers, switches | 31% |
| Task tuning | Adjusting light levels appropriate to the space and its use | Dimmable ballasts | 36% |

As noted in Table 1, the average energy savings from task tuning were found to be 36 percent.

Lighting Controls Terminology prepared by NEMA Lighting Controls Section. Published by the National Electrical Manufacturers Association, January 2013 (NEMA 2013).

NEMA defines task tuning as a lighting control strategy in which the maximum light output of an individual or group of luminaires is set to provide the appropriate amount of light for a space, task or area. Tuning is sometimes accomplished using high-end trim.

Individual Lighting Control: Task Performance, Mood, and Illuminance by Peter Boyce et al. Published in the Journal of the Illuminating Engineering Society, Winter 2000.

The authors explored the effect of individual lighting controls on office workers’ performance and mood, as well as lighting energy consumption. The results of their experiment, which was conducted in three offices and involved 18 test subjects, was that lighting controls did not affect occupants’ mood or performance but did save between 35 and 42 percent on electricity consumption.

LED Office Lighting and Advanced Lighting Control System (ALCS) prepared by EMCOR Energy Services for Pacific Gas and Electric Company, 2012.

PG&E and EMCOR Energy Services tested LED lighting and advanced lighting controls on the tenth floor of the General Services Administration office building in San Francisco. They monitored the existing lighting system and then conducted a four-phase experiment, the second of which tested task tuning using a wireless control system. They found task tuning to provide a consistent reduction in power and a wide range of savings—from 15 to 63 percent.

The Lighting Handbook by David DiLaura et al. Published by the Illuminating Engineering Society, 2011.

This reference handbook provides illuminance recommendations that help lighting designers specify sufficient light for the space and tasks performed in the space. The recommendations are based on scientific research, experience, available technology, economic considerations, best practice and energy concerns.

Lighting Control for the Smart Building, Case Study University Health Network Toronto General Hospital prepared by Encellium.

The R. Fraser Elliot building was built in 2001 and houses Toronto General Hospital's executive suites, administration offices, research labs, food services, and emergency medical services. It was equipped with the most energy-efficient fluorescent lighting available at the time. Hospital management worked with Encellium to reduce lighting energy consumption by 50 percent while maintaining IES recommended illumination levels. The retrofit included task tuning among other measures. As a result of all of the measures implemented, lighting energy consumption was reduced by 74 percent and electric demand by 37 percent, while improving lighting quality. The annual energy cost was reduced by \$0.45 per square foot, equating to a simple payback of four years.

Case Study | the New York Times Building, New York, NY prepared by Lutron Electronics Co., Inc., 2010.

Lutron provided the lighting control system for more than 600,000 square feet of new office space in The New York Times Building. The controls incorporated three strategies: daylight harvesting, occupancy sensing, and light level tuning. Their testing estimated savings of about 20 percent for daylighting, 35 percent for occupancy controls, and 45 percent for light level tuning.

Lighting Technologies Produce Energy Savings by Terry Mocherniak. Published in Energy & Power Management, May 2006.

The author notes that the advent of cost-effective dimmable ballasts and the commercial availability of digital addressable dimming systems have made it possible to control lighting energy load. Employing advanced lighting controls results in 65 to 80 percent energy reduction compared to conventional controls which can achieve 25 to 40 percent reduction from a common baseline.

Paradigm in Sustainability and Environmental Design: Lighting Utilization Contributing to Surplus-Energy Office Buildings by Mohamad Araji et al. Published in Leukos, volume 9, number 1, July 2012.

The author describes the lighting design strategies and control techniques used in the Masdar Headquarters office building in Abu Dhabi. The electric lighting system includes distributed digital controls that create a tunable lighting system and maximizes energy efficiency and system flexibility.

Responsive Lighting Solutions by Joy Wei et al. Prepared for the General Services Administration, 2012.

The authors present the results of a study that evaluated the energy savings, photometric performance and occupant satisfaction of lighting retrofits at seven sites in five federal buildings in California. The lighting retrofits included dimmable ballasts that could be tuned to preferred light levels.

Data Collection

We tested the impact of task tuning on a sample of buildings and spaces with dimmable lighting systems representative of the average system in Minnesota. In selecting our sample for in-depth monitoring, we first identified a set of buildings with a range of light levels. We walked through these buildings and recorded characteristics of both the buildings themselves, as well as the lighting systems. In this way, we could characterize the variety of lighting systems in Minnesota and make qualitative judgments as to what generally leads to high or low light levels. We also used this qualitative characterization to select the final set of lighting systems for in-depth study. Within this smaller building set, we picked those that had lighting systems with light levels ranging from over lit to under lit. The spaces with high light levels served as our experimental group – they were monitored before task tuning and then after – while those with low light levels were our control group and their systems were not altered. We used the data from our experimental group to draw conclusions about the magnitude of energy savings. The control group allowed us to perform quality checks on our analysis method, as well as draw deeper conclusions as to the factors that led to energy efficient lighting design (without the need to tune).

We deployed data loggers that measured electric current and working plane illuminance on all of the systems in our sample and collected data over two separate time periods. For the systems with high light levels, we monitored the control system in its as-found state during period 1. In period 2, the control system was tuned but the other lighting controls, such as occupancy sensors, switches, and time clocks remained functional. For the systems with low light levels, we simply monitored the systems throughout period 1 and period 2 without making any adjustments. These two periods of data collection were spread over five-months.

The energy savings from tuning were determined by taking the difference in energy consumption between these periods, normalized by hours of operation. We then derived potential energy savings metrics based on these measurements. The calculations for each set are outlined in more detail in the Measured Energy Savings section.

Due to the relatively small sample size, our characterization is not statistically significant, nor are the energy savings estimations that follow. However, care was taken to select a range of buildings, spaces, and lighting systems that reflect the greater Minnesota building population as a whole. The two major space types for which task tuning may have significant potential, but are not included in our study, are warehouse/storage and retail spaces. While warehouse/storage facilities have good potential for task tuning due to their low lighting requirements and low occupancy duration, there are not a significant number of dimmable lighting systems in these facilities currently. Therefore they were not included in the study. We did not include retail facilities in the study because we thought it would be difficult to persuade owners to adjust their lighting systems. Typically retail owners tend to believe that lowering light levels on their merchandise will adversely affect product sales.

Buildings studied

We contacted members of the architecture, engineering, education, utility, and research communities to locate spaces with dimmable lighting for our study. From these contacts, we

identified a large number of potential buildings, and conducted preliminary walkthroughs of 18 buildings, corresponding to a range of building types, ages, and owner types. Figure 2 illustrates the percentage breakouts of these categories.

Figure 2: Summary of buildings considered for study (N=18)

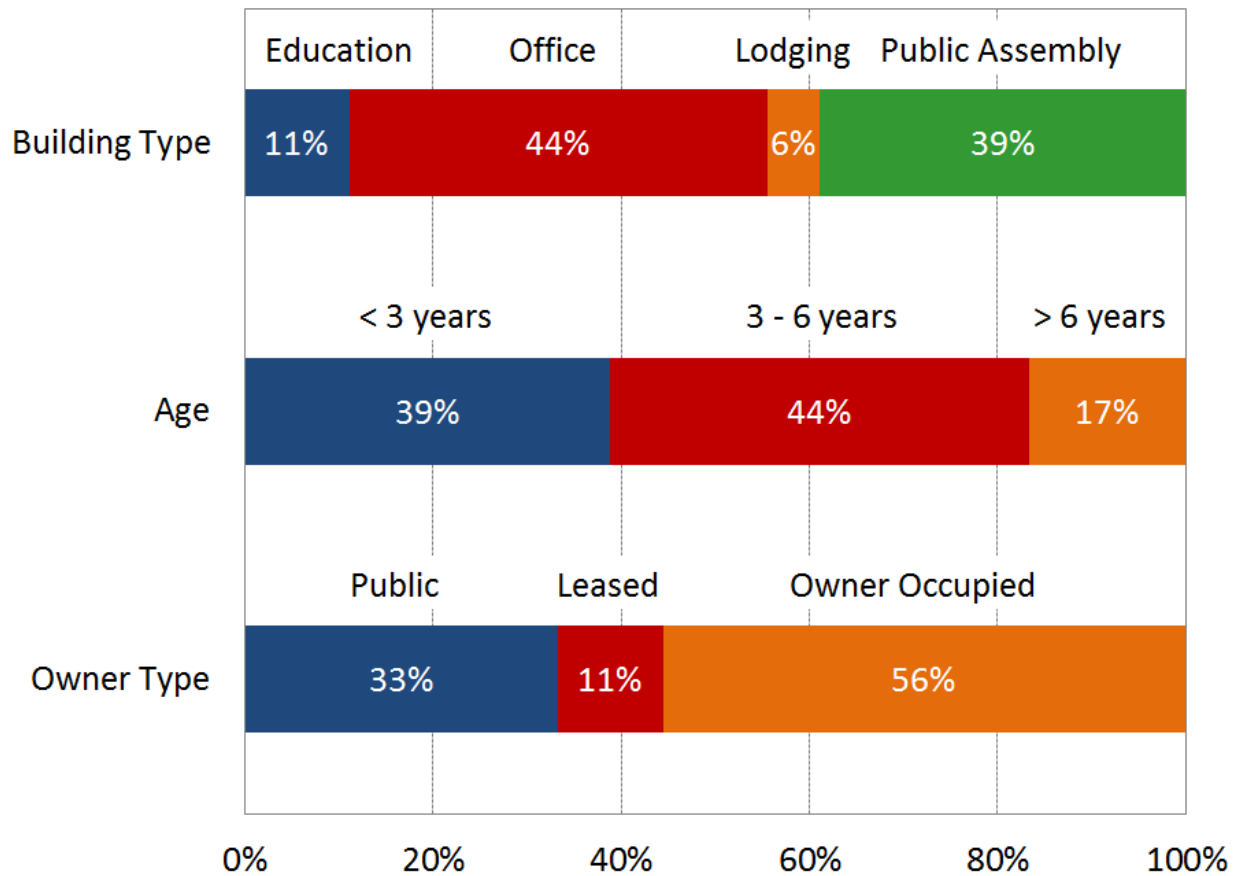

The majority of buildings we identified fell into either office (44 percent) or public assembly (39 percent) building types. The public assembly buildings predominantly are libraries, but there is a performing arts theatre and a transportation hub. The age of the buildings skews towards newer buildings with a relatively close split between buildings under three years of age (39 percent) and between three and six years of age (44 percent). Further, the majority of buildings are owner occupied (56 percent), but one third are public buildings (33 percent).

We visited each of these buildings to identify as many potential spaces within the building as possible for further study. We collected information on geometry, control parameters, lighting parameters, and architectural properties for each potential space in the building. Figure 2 Figure 3 summarizes the key characteristics of the spaces that we considered in this initial set of site visits, and approximates a characterization of typical dimmable spaces in Minnesota.

Figure 3: Summary of spaces considered for study (N=28)

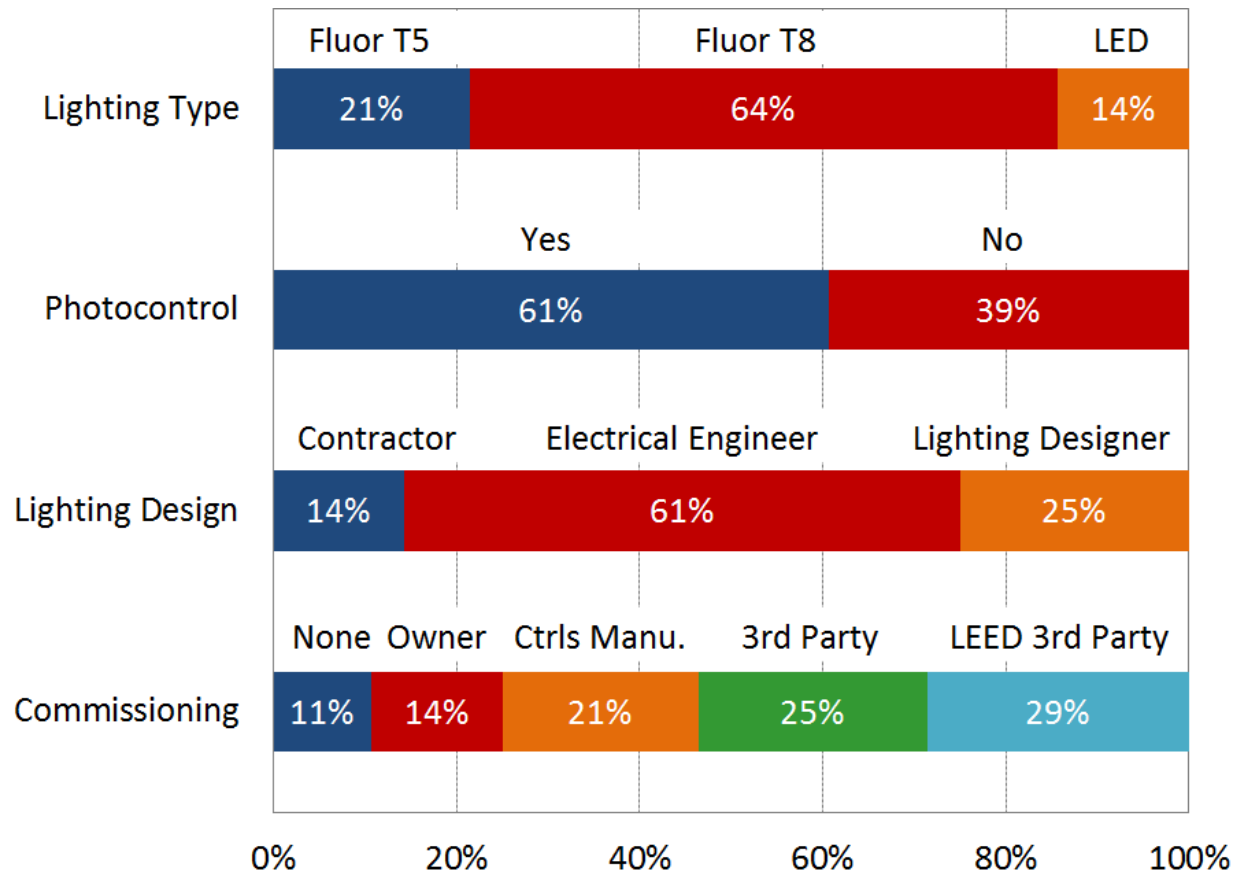

A large majority of the spaces we visited had linear fluorescent fixtures, either T5 (21 percent) or T8 (64 percent) with dimmable ballasts that were controlled by photosensors (61 percent).¹ The spaces with dimmable lighting that were not controlled by photosensors were predominately conference rooms with dimming for the associated A/V equipment. Additionally, the majority of these systems were designed by an electrical engineer (61 percent), with a quarter being designed by a lighting designer (25 percent). The level of commissioning was split relatively evenly across all categories, with most commissioning being done to meet LEED requirements.

Our budget dictated that we narrow our larger sample to approximately 10 systems for in-depth monitoring. Approximately half of this final set would be over lit and the other half under lit. Relative light levels were based on recommendations from the Illuminating Engineering Society (DiLaura 2011) for the activity type in each space. Due to process efficiencies from monitoring multiple spaces per building, we ended up monitoring 17 different lighting systems in 10 different buildings. These final 17 spaces are listed in Table 2, along with key characteristics including lighting type, dimmable lighting power, whether the lights were

¹ As long as linear fluorescent fixtures dominate the market, we will see that dimmable lighting is synonymous with photocontrol. However, as the LED market expands over the coming years we anticipate that more spaces, such as interior open offices that do not have daylighting, will be dimmable. Unlike linear fluorescents which require special dimming ballasts attached to a photosensor control, dimmability is built into LEDs.

also controlled by a photosensor, who designed the lighting system, and who commissioned the system.

Table 2: Monitored space characteristics

| ID | Building | Location | Space Description | Lighting Type | Dimmable Power (kW) | PC ? | Lighting Design | Level of Cx |
|---------|------------|---------------------|------------------------|---------------|---------------------|------|---------------------|-----------------------|
| Conf 1 | Building A | Minneapolis, MN | Conference | LED | 0.21 | No | Lighting Designer | LEED 3rd Party |
| Train | Building A | Minneapolis, MN | Training Room | LED | 0.30 | No | Lighting Designer | LEED 3rd Party |
| Comp 1 | Building B | Northfield, MN | Computer Lab | Fluor T8 | 0.17 | Yes | Contractor | Controls Manufacturer |
| Comp 2 | Building B | Northfield, MN | Computer Lab | Fluor T8 | 0.17 | Yes | Contractor | Controls Manufacturer |
| Class | Building C | Northfield, MN | Classroom | Fluor T8 | 0.40 | Yes | Contractor | Controls Manufacturer |
| O Off 1 | Building D | Madison, WI | Open Office | Fluor T8 | 0.35 | Yes | Lighting Designer | LEED 3rd Party |
| Study | Building E | Brooklyn Center, MN | Study Area | Fluor T8 | 0.25 | Yes | Electrical Engineer | None |
| Stack | Building E | Brooklyn Center, MN | Library Stacks | Fluor T8 | 1.71 | Yes | Electrical Engineer | None |
| O Off 2 | Building F | Maple Grove, MN | Open Office | Fluor T5 | 1.07 | Yes | Electrical Engineer | Owner |
| Comp 3 | Building G | Plymouth, MN | Computer Lab | Fluor T5 | 2.89 | Yes | Electrical Engineer | Controls Manufacturer |
| O Off 3 | Building G | Plymouth, MN | Open Office | Fluor T5 | 1.35 | Yes | Electrical Engineer | Controls Manufacturer |
| Bar | Building H | Minneapolis, MN | Bar | LED | 0.33 | No | Electrical Engineer | 3rd Party |
| Conf 2 | Building I | Madison, WI | Conference | Fluor T5 | 0.36 | No | Electrical Engineer | 3rd Party |
| O Off 4 | Building I | Madison, WI | Open Office | Fluor T8 | 0.28 | Yes | Electrical Engineer | 3rd Party |
| Trans | Building J | St Paul, MN | Transportation Waiting | Fluor T8 | 5.13 | Yes | Electrical Engineer | 3rd Party |
| Conf 3 | Building J | St Paul, MN | Conference | LED | 0.10 | No | Electrical Engineer | 3rd Party |
| P Off | Building K | Minneapolis, MN | Private Office | Fluor T8 | 0.10 | Yes | Electrical Engineer | Owner |

Note that three of the spaces are in Wisconsin rather than Minnesota. It was beneficial to study a few spaces in immediate proximity so we could conduct more frequent, detailed visits, especially early in the experimental setup. Any difference in lighting systems between these regions is expected to be minor due to the similar climate and latitude, and resulting available daylight.

Data Acquisition Protocol

We installed continuous monitoring equipment in each space to collect several data points across the periods discussed above. Period 1 of continuous data monitoring began on Saturday, May 10th at 12:00 am CT, and monitoring concluded at the end of Period 2 on Friday, October 17th at 12:00 pm CT. The following points were continuously monitored on five minute intervals with individual data loggers:

- **Current of dimmable lighting circuit(s).** A properly rated current transducer was placed on the dimmable lighting circuit or circuits to measure the electric lighting's current.
- **Critical 'Workplane' illuminance.** Illuminance at the critical workplane was measured via factory-calibrated photosensors placed in the space. The critical workplane is defined as the location served by the dimmable lighting circuit where someone would be performing a task (i.e. not in the corner of the room) with the lowest light level. This typically led to locations, such as desktops, that were away from windows and not directly below a light fixture.

In addition to these continuous measurements, we used handheld equipment to take spot measurements once during our preliminary visit of the following:

- **Voltage and power factor.** A power quality meter was used to measure the voltage and power factor of the dimmable lighting circuit or circuits. This data was collected at multiple dimming positions to determine the effect of lighting control scenarios on voltage and power factor.
- **Illuminance and current measurements for system performance.** We also took simultaneous measurements of illuminance at the critical workplane using a factory-calibrated handheld illuminance meter and electric current at multiple dimming positions. These coincident measurements were used to understand the relationship between a system's power and the amount of light received at the critical workplane. This process is covered in more detail in the Lighting System Measurements section.
- **Average illuminance.** We took multiple measurements of illuminance throughout the space. These measurements were used to calculate the average illuminance in the space, as well as correlate it to the illuminance at the critical workplane. This process is covered in more detail in the Lighting System Measurements section.

Finally, we collected data on occupant perception of the spaces and lighting systems. First, we conducted a short interview with each primary building contact, generally a facility manager or engineer. We then distributed a brief survey for the occupants who actually used the spaces we studied (see Appendix A: Occupant Survey and Results).. The results of the interviews and surveys alerted us to any unusual operational impacts or space constraints that might make our results less relevant. More importantly, we wanted to be sure this report included qualitative explanations for the quantitative results that were not based solely on our own suppositions.

The ultimate goal in collecting all these measurements was to determine the energy savings from tuning the lighting system. The measurements outlined above ultimately led to this savings calculation which is summarized in detail in the Measured Energy Savings and Theoretical Energy Savings sections.

Methodology and Analysis

The key savings metrics in this study are:

1. Actual energy savings associated with tuning a lighting system. This metric was developed through direct measurement of lighting power both before and after tuning.
2. Theoretical energy savings associated with tuning a lighting system. This metric was calculated based on measured illuminance and lighting power. It includes analysis of the interactive effects of tuning and photocontrol.

Each metric was calculated only for the lights *that were dimmable* and the associated area.

Lighting System Measurements

We began our analysis by understanding the lighting systems in their untuned, or as-found, state. This involved measuring two key characteristics of a given space's lighting system; its critical workplane illuminance-to-power performance curve and the average illuminance it provided to the working plane.

To determine a lighting system's critical workplane illuminance-to-power performance curve, we first installed our long term current and illuminance monitoring equipment. Note that the illuminance monitoring equipment was installed at the critical workplane, which is the location in the space where someone would be performing a task that has the lowest illuminance level. We then enabled the monitoring equipment's real-time reporting feature. As we manually adjusted the lighting system's output, we were able to record the current and illuminance at various performance points. These points included

1. Lights Off: This point establishes a baseline illuminance without any electric light present. It therefore includes any daylight. This baseline illuminance will be subtracted from subsequent illuminance measurements to calculate electric illuminance from total illuminance.
2. Lights On, Minimum: This point captures the system's minimum current and illuminance output.
3. Lights On, Dimmed: If the system had previously been tuned or had daylight controls, this point captured that level. For systems that had not been tuned or did not have daylight controls, we used only the minimum power measurement to establish the shape of the curve.
4. Lights On, Full: This point captures the system's maximum current and illuminance output.

The current measurements were then converted into power via our spot measurements of the lighting system's voltage and power factor. Figure 4 illustrates an example system's critical workplane illuminance as a function of power. All of our monitored systems had a linear relationship.

Figure 4: Example lighting system's measured critical workplane illuminance versus power.

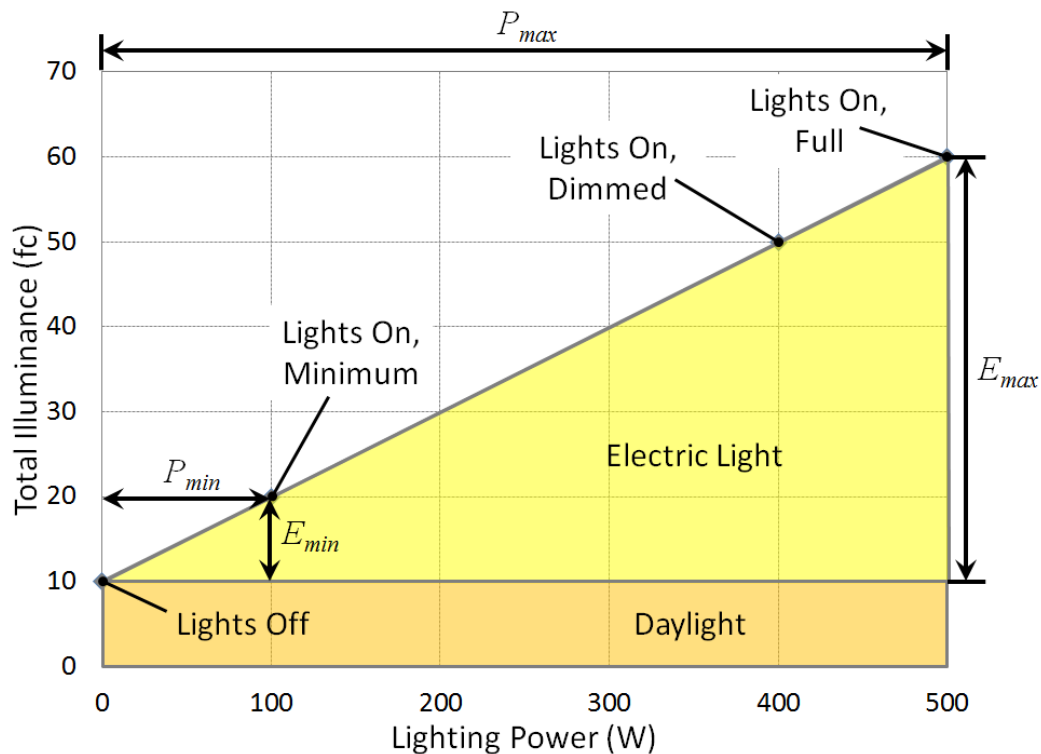

Once the daylight portion of the illuminance was subtracted, we then created a linear fit to the remaining electric-only illuminance data. The result of this was a set of coefficients that expressed the amount of electric light at the critical workplane as a function of lighting power. Note that this set of measurements also defined additional key parameters that were used subsequently in calculating energy savings. The first set is the lighting system's minimum power, P_{min} , and illuminance, E_{min} . These parameters were defined as the system's lighting power and illuminance at the "Lights On, Minimum" position. The second set is the lighting system's maximum power, P_{max} , and illuminance, E_{max} . These parameters were defined as the system's lighting power and illuminance at the "Lights On, Maximum" position.

The next characteristic we measured was the average illuminance the lighting system provided to the working plane throughout the space. One method for calculating average illuminance is to take readings on a 2' x 2' grid throughout the entire space and then average the measurements. However, this method is time-intensive, requiring a large number of readings for even relatively small spaces. We therefore followed the IES Lighting Handbook's procedure for calculating average illuminance. This procedure is more focused, defining key positions for illuminance readings based on a given lighting system's luminaire configuration type. Care should be taken to eliminate any daylight from these measurements. For example, if significant daylight was present, we took a reading at a given location with the lights on followed immediately by a reading with the lights off. The difference between these readings is the electric-only illuminance, and was used for calculating the average illuminance. Figure 5 shows one luminaire configuration type: the Regular Area with Single Row of Continuous Luminaires.

Figure 5: Light meter measurement points for Regular Area with Single Row of Continuous Luminaires.

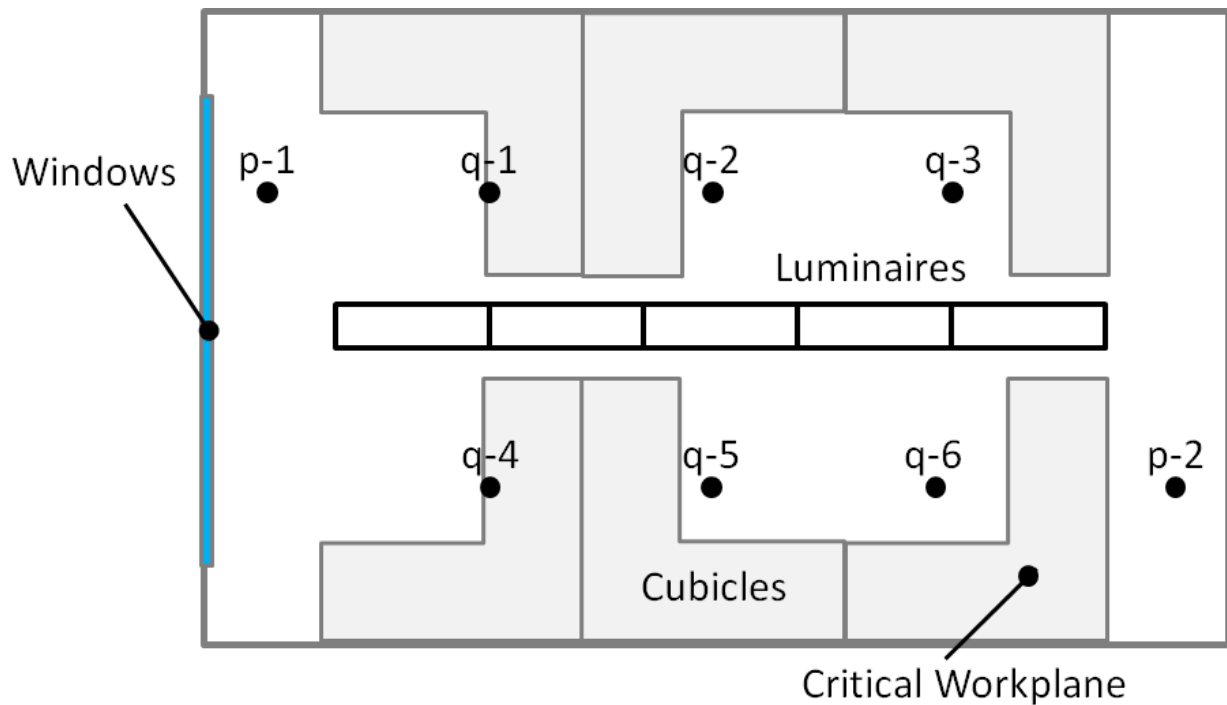

Note that the measurement points (i.e. p-1, p-2, q-1...) are specific to the luminaire configuration type, and the number of total points is greatly reduced when compared to a regular a 2' × 2' grid. The average untuned illuminance, $E_{ave,untuned}$ for this specific luminaire configuration is given by:

$$E_{ave,untuned} = \frac{Q(N - 1) + P}{N}$$

Where:

N is the number of luminaires,

Q is the average of the illuminance measurements taken at the q-labeled points, and

P is the average of the illuminance measurements taken at the p-labeled points.

Other luminaire configurations have different key measurement points and different equations for finding the average illuminance.

As part of the average illuminance measurement process, we also recorded the illuminance at the critical workplane. The critical workplane is a location where an occupant would be performing a task but is away from the windows and luminaires. This reading established a relationship between the critical workplane illuminance and the average illuminance in the space. This relationship would later serve as a means to map the average illuminance that we were targeting as part of our tuning effort to a single light meter measurement that we could view in real-time while making adjustments to the lighting system.

Lighting System Adjustment

Once we understood the performance characteristics of the lighting systems, we launched our data monitoring equipment to begin long-term data gathering of the lighting systems in the untuned, as-found state (period 1). Figure 6 illustrates the monitored lighting power of a lighting system without photocontrol over five days.

Figure 6: Monitored lighting power in a space without photocontrol over five days during period 1.

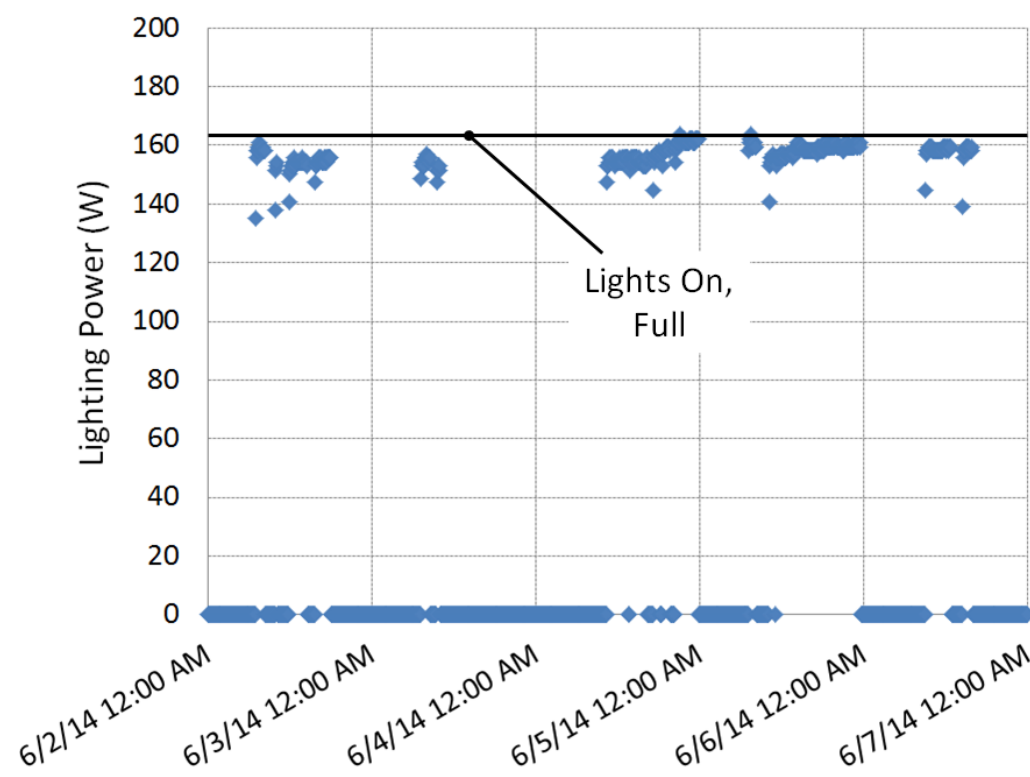

The space monitored in Figure 6 was a computer lab, which accounts for the somewhat sporadic usage schedule, with lights turning on and off at different times for different days. This space was not controlled by a photosensor as seen in the relatively binary (on/off) lighting power. When the lights are on, they are on near their full power of approximately 160 W.

Figure 7 illustrates the monitored lighting power of a lighting system with photocontrol over five days.

The space monitored in Figure 7 was an office, which accounts for the much more consistent usage schedule, with lights turning on and off at approximately the same time each day. This space was controlled by a photosensor as seen in the steadily decreasing lighting power as the available daylight increased throughout the morning and into the afternoon. This effect is inverted in the late afternoon and evening with increasing lighting power as available daylight decreased throughout the afternoon and into the evening.

Figure 7: Monitored lighting power in a space with photocontrol over five days during period 1.

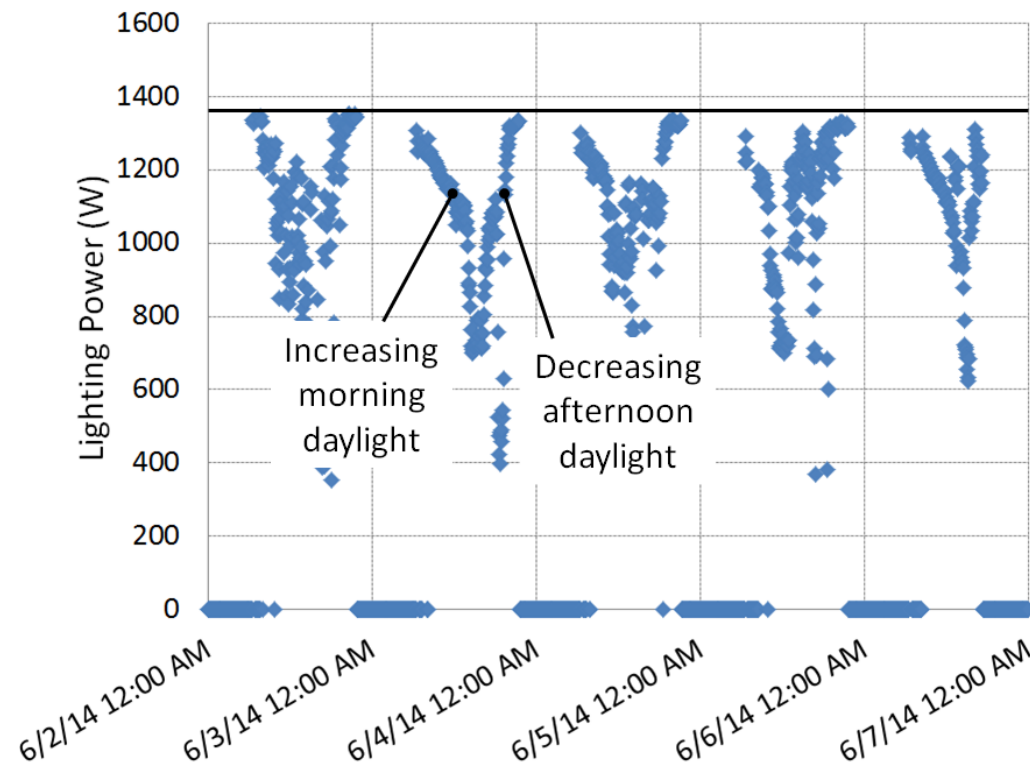

While our monitoring equipment was gathering data during period 1, we compared the untuned average illuminance that we initially measured for each space with the recommended light level based on the IES Lighting Handbook (DiLaura 2011). Table 3 outlines the difference between the untuned and recommended average illuminance for each of our monitored spaces.

Table 3: Untuned and recommended average illuminance for each space

| ID | Space Description | Average Illuminance (fc) | | Percentage Reduction |
|---------|------------------------|--------------------------|-------------|----------------------|
| | | Untuned | Recommended | |
| O Off 2 | Open Office | 78.6 | 30 | 62% |
| Bar | Bar | 13.9 | 7.5 | 46% |
| Stack | Library Stacks | 32.7 | 20 | 39% |
| Comp 1 | Computer Lab | 48.7 | 30 | 38% |
| Comp 2 | Computer Lab | 44.2 | 30 | 32% |
| Study | Study Area | 36.2 | 30 | 17% |
| Class | Classroom | 46.8 | 40 | 15% |
| Trans | Transportation Waiting | 15.1 | 15 | 1% |
| Conf 1 | Conference | 28.4 | 30 | -6% |
| Conf 2 | Conference | 34.4 | 40 | -16% |
| Train | Training Room | 31.1 | 40 | -29% |
| Conf 3 | Conference | 22.7 | 30 | -32% |
| O Off 1 | Open Office | 12.8 | 17 | -33% |
| O Off 4 | Open Office | 15.6 | 22 | -41% |

| ID | Space Description | Average Illuminance (fc) | | Percentage Reduction |
|---------|-------------------|--------------------------|-------------|----------------------|
| | | Untuned | Recommended | |
| Comp 3 | Computer Lab | 20.3 | 30 | -48% |
| O Off 3 | Open Office | 19.9 | 30 | -51% |
| P Off | Private Office | 13.6 | 30 | -121% |

When the lighting designer of a given space provided us with their target average illuminance, we used it in place of the IESNA recommended value. The spaces in which this occurred are indicated in Table 3 as recommended average illuminances in bold and italics.

The amount that the light levels in a space needed to be reduced to be in line with IESNA recommendations was defined by:

$$\%_{reduction} = \frac{E_{ave,untuned} - E_{ave,recommended}}{E_{ave,untuned}}$$

Where:

$E_{ave,recommended}$ is the IESNA or Design Target illuminance, and

$E_{ave,untuned}$ is the average illuminance of the space measured prior to tuning.

Note the wide range of both over lit (maximum = 62 percent) and under lit (minimum = -121 percent) spaces. The midpoint of this set is -6 percent, while the average was -7 percent, meaning that we accomplished our goal of identifying a range of both over lit and under lit spaces to study. Figure 8 illustrates the percentage that the spaces were either over lit or under lit in comparison to the IESNA illuminance recommendations in descending order.

Figure 8: Percentage that a space was over lit or under lit in comparison to the IESNA illuminance recommendations in descending order.

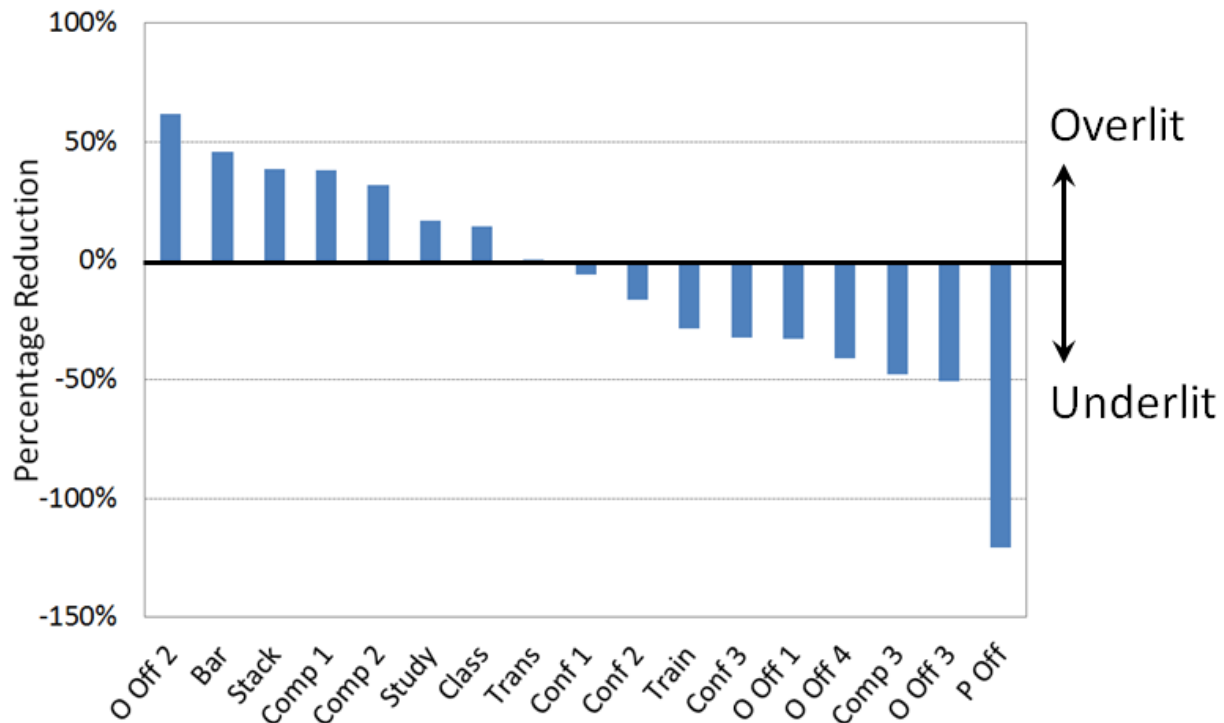

Any space above zero in Figure 8 was over lit while any space below zero was under lit. Monitoring for under lit spaces continued without adjustment. Over lit spaces were tuned using the understanding of which spaces were over lit and by how much and following the procedures outlined in Appendix B: Task Tuning Checklist.

In brief, for systems without daylight controls, we adjusted the system’s high end trim until the illuminance that we measured at the critical working plane matched our calculated tuned critical illuminance (see formula below). For systems with daylight controls, we adjusted the system’s photosensor setpoint in the same manner. The tuned critical illuminance, $E_{crit,tuned}$ was calculated by:

$$E_{crit,tuned} = E_{crit,untuned} \left(\frac{E_{ave,recommended}}{E_{ave,untuned}} \right)$$

Where:

$E_{crit,untuned}$ is the untuned critical illuminance measured at the critical workplane during the average illuminance measurements.

This equation assumes that illuminance at the critical workplane is linearly proportional to the average illuminance of the space.

During the tuning process, we attempted to adjust each of the over lit systems to the IESNA recommended lighting levels. However, we also used real-time feedback from the occupants to understand whether the recommended light levels were too bright or too dim. In several over lit spaces, occupants preferred light levels that differed from the IESNA recommended light levels.

Table 4: Untuned, recommended and preferred average illuminance for each space that was adjusted to a level other than the IESNA recommendations.

| ID | Space Description | Average Illuminance (fc) | | | Percentage Reduction | |
|------------|-------------------|--------------------------|-------------|-----------|----------------------|-----------|
| | | Untuned | Recommended | Preferred | Recommended | Preferred |
| O Off 2 | Open Office | 78.6 | 30 | 60.0 | 62% | 24% |
| Bar | Bar | 13.9 | 7.5 | 10.4 | 46% | 25% |
| Stack | Library Stacks | 32.7 | 20 | 17.8 | 39% | 46% |
| Conf 2 | Conference | 34.4 | 40 | 20.5 | -16% | 40% |
| Comp 3 | Computer Lab | 20.3 | 30 | 17.2 | -48% | 15% |
| O Off 3 | Open Office | 19.9 | 30 | 16.9 | -51% | 15% |

In addition, feedback gathered from building occupants and staff in several of the spaces identified as under lit indicated that occupants wanted even lower light levels. This surprising result meant that there is room for task tuning saving in some spaces that IESNA would classify as under lit. Based on this feedback, we reclassified these spaces as over lit and modified our methodology to adjust the light levels in these additional spaces to the user preferences. Table 4 illustrates the difference in untuned, recommended and preferred light levels in spaces that we adjusted to levels other than those recommended by IESNA. The percent reduction for the recommended light levels is calculated as outlined in the equation above. The percent reduction

for the preferred light levels is similarly calculated, but using the preferred as opposed to the recommended light level.

Figure 9 illustrates the percentage that the untuned spaces were either over lit or under lit in comparison to both the IESNA illuminance recommendations, as well as the occupant preferred illuminance level that we were able to achieve.

Figure 9: Percentage that a space was over lit or under lit in comparison to the IESNA illuminance recommendations and occupant preferred illuminance levels that we were able to achieve.

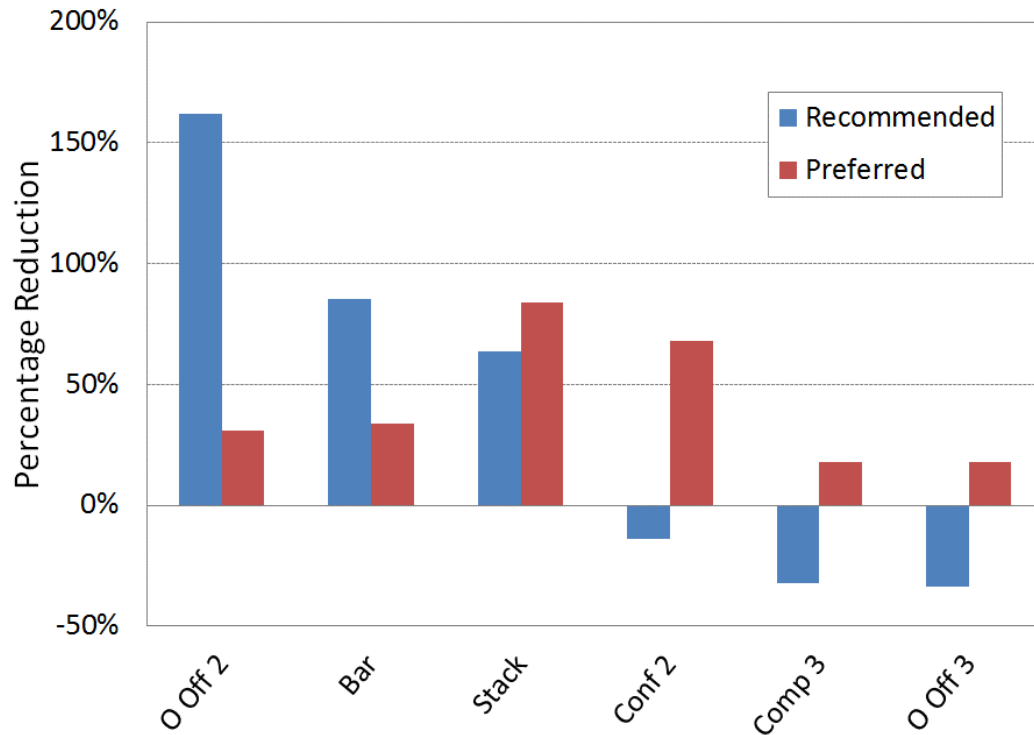

In spaces O Off 2 and Bar, we received immediate occupant feedback during our tuning efforts that the IESNA recommended illuminance was too low. We therefore increased the light levels until the occupants were comfortable with them. This increased occupant satisfaction, but decreased the energy savings associated with tuning these two spaces. In Stack, we received occupant feedback during our tuning efforts that the IESNA recommended illuminance was too high. We therefore decreased the light levels further until the occupants were comfortable with them. This increased occupant satisfaction, while increasing the potential energy savings from tuning this space. During our preliminary site visits, we learned that building staff in Conf 2, Comp 3, and O Off 3 preferred light levels below the IESNA recommendations. We therefore included these three spaces in our subsequent tuning efforts, allowing us to capture savings from spaces where we originally assumed there would be none.

We then monitored the systems in the tuned state (period 2). Figure 10 illustrates the average hourly lighting power both before tuning and after tuning for one of the monitored spaces. The data over each period has been combined to create an average day both before and after tuning.

Figure 10: Average hourly lighting power both before and after tuning.

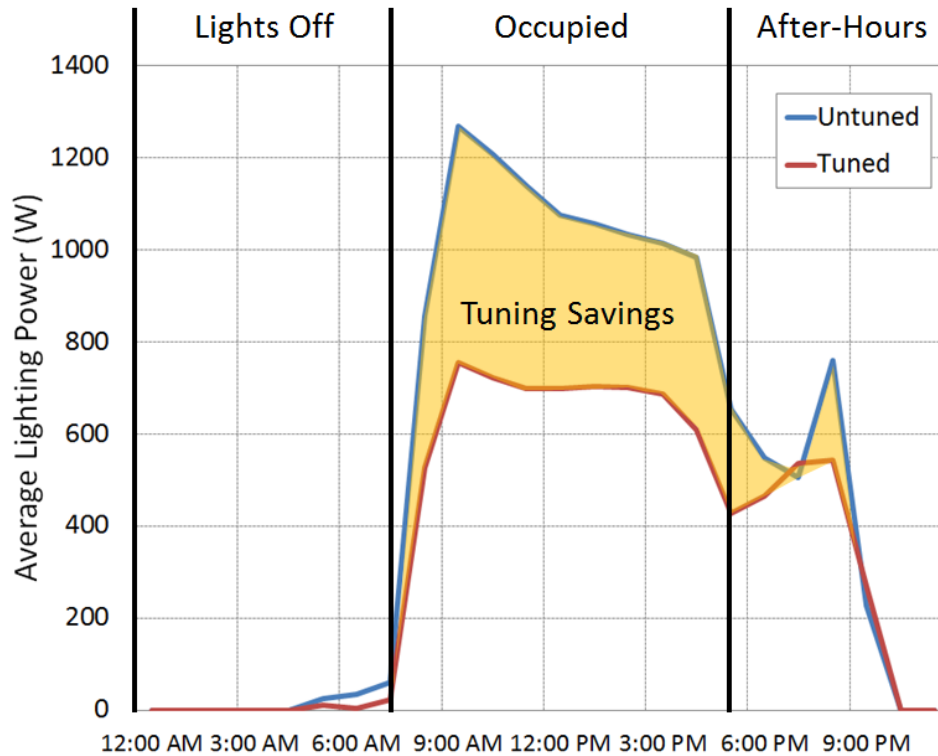

For the untuned data from period 1, the lights are off until the occupants arrive in the morning around 7:00 am. The lighting power peaks around 1,250 W, and decreases somewhat throughout the day. At about 5:00 pm, the lighting power decreases significantly, as the occupants go home. Sporadic usage then occurs throughout the evening due to after-hours events and cleaning crews. The lights are finally shut off at 10:00 pm.

A similar profile is seen for the tuned data from period 2. However, the average lighting power is reduced from around 1,100 W to around 700 W during the fully occupied daytime hours. This reduction illustrates the energy savings potential from task tuning over lit spaces.

Measured Energy Savings

Once we had collected all of our monitored data from both period 1 and period 2, we calculated energy savings from task tuning. We only calculated measured energy savings for the spaces in which we actually adjusted the light levels through task tuning. The measured lighting energy usage, $W_{meas,j}$ was calculated using the electrical current measurement, which was taken in five-minute intervals, and the spot measurement of the circuit's voltage and power factor. This allowed us to calculate lighting energy usage for a given space for a given period, j :

$$W_{meas,j} = V \cdot PF \cdot \sum_{i=1}^{n_{measurements,j}} I_i \cdot \left(\frac{1 \text{ hr}}{12 \text{ samples}} \right)$$

Where

V is the voltage of the electrical circuit,
 PF is the power factor of the electrical circuit,
 I_i is the sampled current at timestep i , and
 $n_{measurements,j}$ is the number of measurements in the particular period.

For a given space, each period had a different usage schedule. For instance, in a classroom one period could have more hours of operation due to a different class schedule. We therefore normalized the energy consumption between periods by the total hours of operation of the lighting system in each period. We first calculated the number of hours that the lights were on in a given period, $\tau_{on,j}$:

$$\tau_{on,i,j} = \begin{cases} 0, & P_i < P_{min} \\ 1, & P_i \geq P_{min} \end{cases}$$

$$\tau_{on,j} = \sum_{i=1}^{n_{measurements,j}} \tau_{on,i,j} \cdot \left(\frac{1 \text{ hr}}{12 \text{ samples}} \right)$$

where $\tau_{on,i,j}$ is an indicator of whether the lights are on or off for a given time interval. This is determined by whether the power measured during that time interval, P_i , is greater than or less than the system's minimum power. If the measured power is greater than or equal to the system's minimum power, then the lights are considered on for that time interval. If the measured power is less than the system's minimum power, then the lights are considered off for that time interval.

The normalized lighting energy usage, $W_{norm,j}$ for each period was then calculated by:

$$W_{norm,j} = \frac{W_{meas,j}}{\tau_{on,j}}$$

Once we had a normalized lighting energy usage for each period, we calculated the percent savings from tuning, $Savings_{meas,\%}$ by:

$$Savings_{meas,\%} = \frac{W_{norm,1} - W_{norm,2}}{W_{norm,1}}$$

$W_{norm,1}$ and $W_{norm,2}$ are the normalized lighting energy usage for period 1 and 2, respectively.

Besides a percent savings, we also calculated a metric that quantified the amount of electricity savings for a given space based on its dimmable lighting power, $Savings_{meas,kWh/kW}$. This savings metric is useful in that it reflects the magnitude of savings and not just the percentage of savings. The percentage savings is most dependent on the percentage that the space is over lit, increasing in tandem with the increase in the percentage that a system is over lit. However, other key characteristics, such as hours of operation and dimmable lighting power are effectively canceled out in percent savings calculation. The $Savings_{meas,kWh/kW}$ metric accounts for these additional characteristics, increasing as percent over lit, hours of operation, and dimmable lighting power increase. It therefore can differentiate between systems with greater potential for absolute energy savings and not merely large percent savings. Its units are kilowatt-hours saved divided by kilowatts of dimmable power. In order to calculate this metric, we first calculated each period's measured lighting energy per dimmable lighting power, $K_{meas,j}$:

$$K_{meas,j} = \frac{W_{meas,j}}{P_{max,dim}}$$

$P_{max,dim}$ is only the dimmable lighting power in the space and does not include any non-dimmable lighting power that was on the monitored circuit. Our periods were of varying length and each shorter than an entire year. In order to extrapolate this metric to annual energy savings, we calculated the number of hours that the lights would be on each year, $\tau_{on,ann}$:

$$\tau_{on,ann} = \frac{\tau_{tot,ann}}{2} \left(\frac{\tau_{on,1}}{\tau_{tot,1}} + \frac{\tau_{on,2}}{\tau_{tot,2}} \right)$$

Where:

$\tau_{tot,ann}$ is the total number of hours in a year (8760),

$\tau_{on,1}$ and $\tau_{on,2}$ are the hours the lights were on in each period, calculated previously, and

$\tau_{tot,1}$ and $\tau_{tot,2}$ are the total hours of each period.

The measured lighting energy per dimmable lighting power for each period was then normalized by:

$$K_{norm,j} = K_{meas,j} \left(\frac{\tau_{on,ann}}{\tau_{on,j}} \right)$$

The lighting energy savings per dimmable lighting power was then calculated by:

$$Savings_{meas,kWh/kW} = K_{norm,1} - K_{norm,2}$$

Theoretical Energy Savings

Measured energy savings described in the previous section represents the most definitive estimate of energy savings from task tuning. However, direct measurement does not allow for answering certain questions such as:

- Can energy savings be estimated if you do not have both untuned and tuned measurements?
- What would the savings have been if the lights had been tuned to the IESNA recommended light levels as opposed to the occupant preferred light levels?
- Can a correlation be developed between energy savings and percent reduction that would allow a utility program to quickly estimate energy savings?
- Is there any relationship between energy savings and high-level lighting system characteristics?

In order to answer these interesting questions, we developed a set of theoretical energy savings estimates. The calculations are not period by period comparisons, but rather instantaneous savings calculations at every time interval. The savings for a given interval is calculated by taking the difference between what would have happened at that point in time had both tuning occurred and not occurred. The interval savings are then summed over the period to calculate total savings. We applied these calculations to all of the spaces that we monitored, including those that we did not tune. Since the spaces we did not tune were underlit, the calculations for these spaces lead to energy penalties, as opposed to energy savings.

To begin this discussion, we will outline the simpler of the two fundamental types of systems that we studied; *those without photocontrol*. The lighting power of a system without photocontrol over a typical day is illustrated in Figure 11.

Figure 11: Untuned lighting power for a system without photocontrol over a typical day.

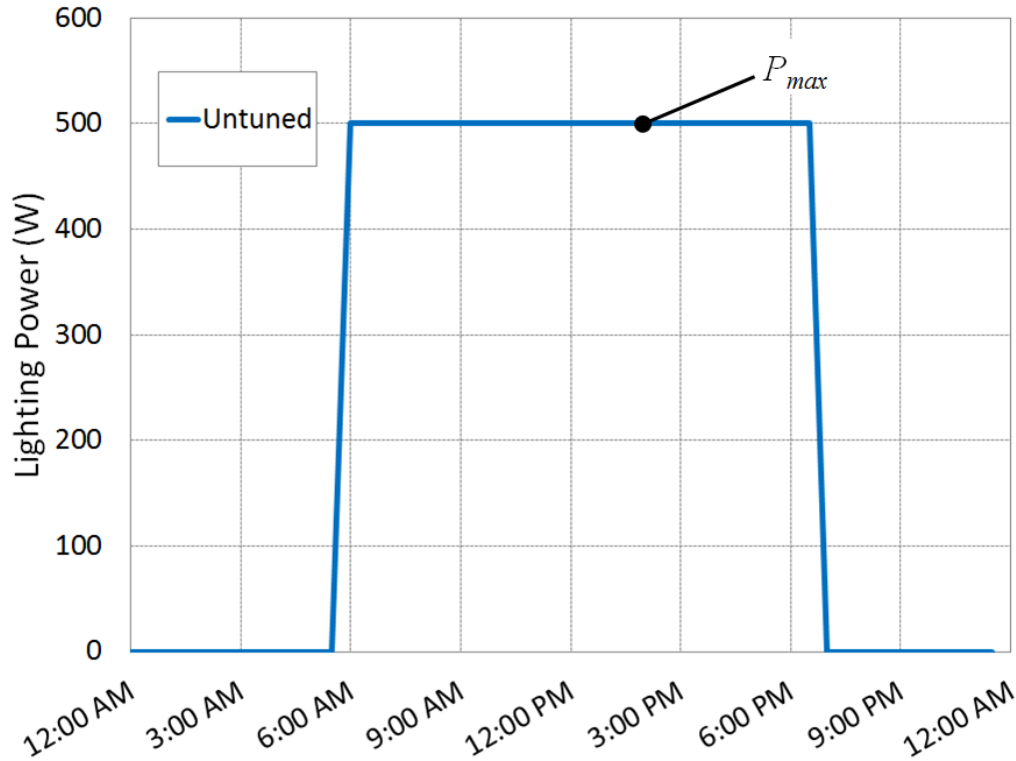

In this idealized case, the untuned lighting system is off overnight. When the first occupant arrives at 6:00 am, the lights come on to their untuned full power, P_{max} . The lights remain at full power until the last occupant leaves for the evening at 7:00 pm, at which point they are shut off.

From our previous calculations we know both the tuned and untuned critical illuminances. We can calculate the illuminance savings from tuning, $E_{theor,savings}$ by:

$$E_{theor,savings} = E_{crit,untuned} - E_{crit,tuned}$$

From Figure 4, we know that electric illuminance is a function of lighting power, given by:

$$E = m \cdot P + b$$

Where:

m is the linear fit's slope, and

b is its y-intercept

Substituting and simplifying leads to:

$$E_{theor,savings} = m(P_{untuned} - P_{tuned})$$

Where:

$P_{untuned}$ is the untuned lighting power, and

P_{tuned} is the tuned lighting power taken at the critical workplane illuminance.

The difference in these two powers defines the power savings from tuning, $P_{theor,savings}$. The difference in theoretical savings between any tuned lighting level (i.e. the IESNA recommendations versus occupant preferred) may easily be calculated by adjusting the $E_{crit,tuned}$ accordingly.

$$P_{theor,savings} = P_{untuned} - P_{tuned}$$

Substituting and solving for power gives:

$$P_{theor,savings} = \frac{E_{theor,savings}}{m}$$

This calculation can be visualized by revisiting Figure 4, this time without the daylight component of illuminance. Figure 12 illustrates an example lighting system's power and illuminance savings from task tuning.

Figure 12: Power and illuminance savings from task tuning without photocontrol.

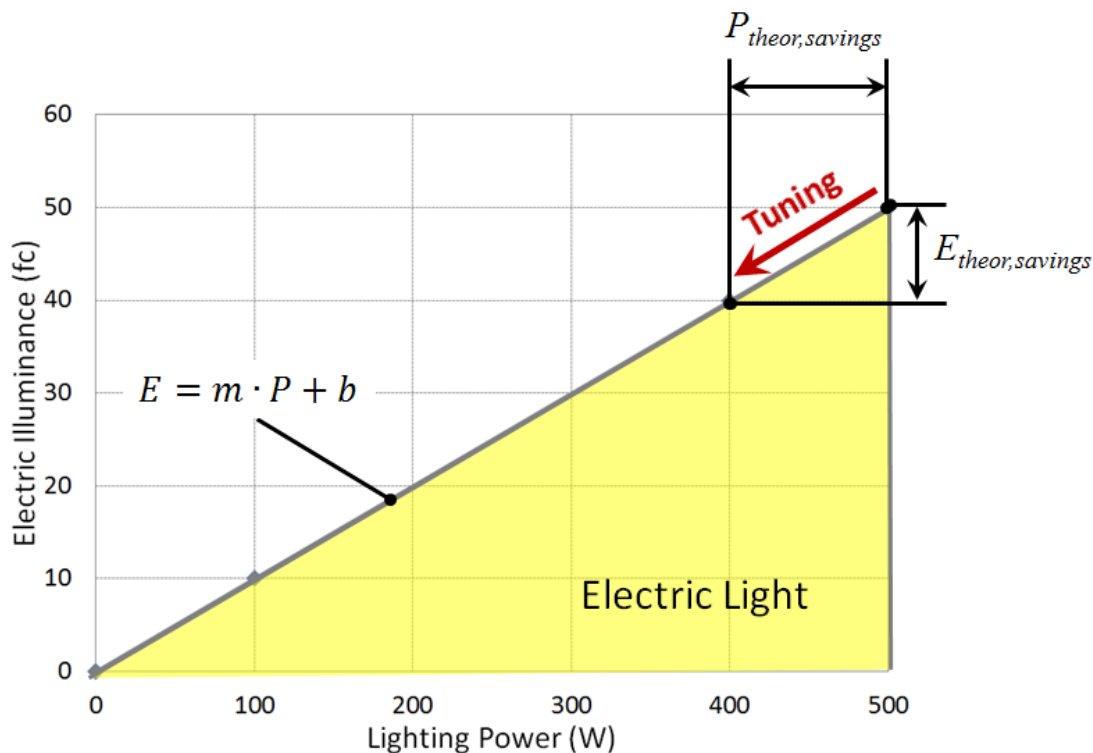

The high end trim is reduced by 10 fc, from 50 fc to 40 fc. This results in a power savings of 100 W, from 500 W to 400 W. These savings are instantaneous for a given time interval and must be summed over the hours of operation to calculate energy savings. Figure 13 shows this process by illustrating the lighting power of a system without photocontrol over a typical day both before and after tuning.

Figure 13: Tuned and untuned lighting power for a system without photocontrol over a typical day.

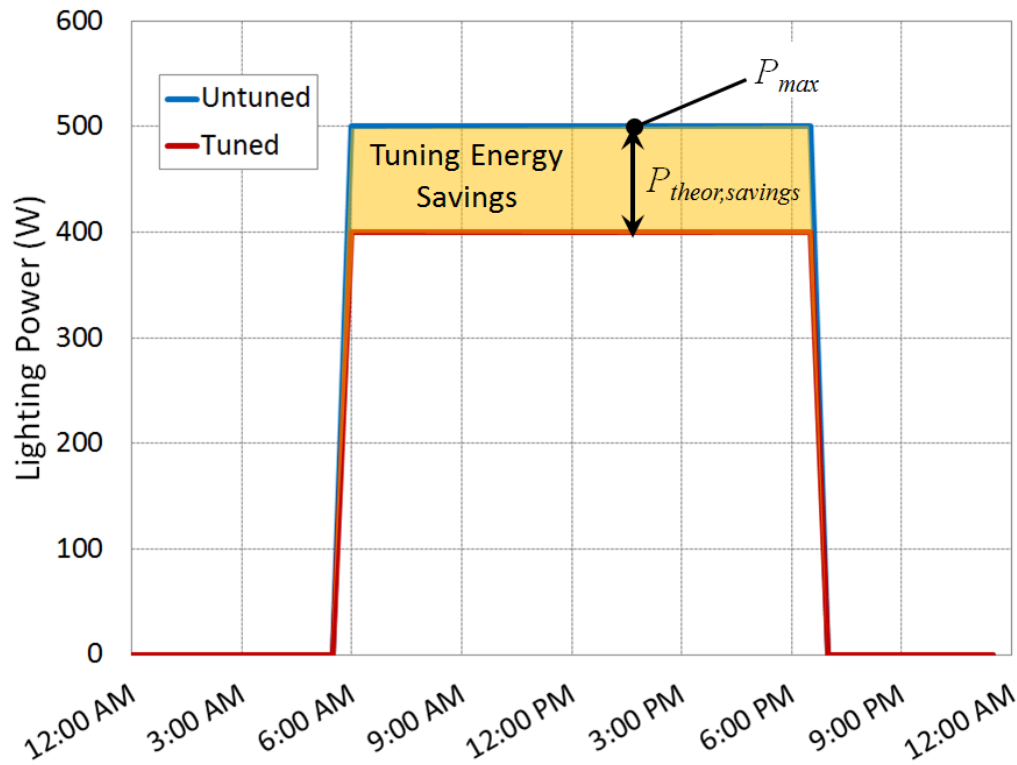

After tuning, the lighting system behaves in much the same manner as before. However, when the lights are turned on in the morning, they come on to their tuned power, as opposed to their untuned power. The power savings summed over the hours that the lights are on in a given period is the theoretical energy savings from task tuning.

$$W_{theor,savings} = P_{theor,savings} \cdot \tau_{on,j}$$

If the system had not already been tuned, the theoretical percent savings, $Savings_{theor,\%}$ is calculated by:

$$Savings_{theor,\%} = \frac{W_{theor,savings}}{W_{meas,j}}$$

If the system had already been tuned, the theoretical percent savings is calculated by:

$$Savings_{theor,\%} = \frac{W_{theor,savings}}{W_{meas,j} + W_{theor,savings}}$$

This accounts for the fact that the measured energy consumption in a tuned period does not include the energy from the tuning itself. The theoretical savings, $Savings_{theor,kWh/kWh}$ is calculated by:

$$Savings_{theor,kWh/kWh} = \left(\frac{W_{theor,savings}}{P_{max,dim}} \right) \left(\frac{\tau_{tot,ann}}{\tau_{tot,j}} \right)$$

The added term is a ratio of total hours in a year to the total hours in the given period. This term scales the calculation to represent energy savings over an entire year.

We now address the more complex of the two fundamental types of systems that we studied; *those with photocontrol*. The lighting power of a system with photocontrol over a typical day is illustrated in Figure 14.

Figure 14: Tuned and untuned lighting power for a system with photocontrol over a typical day without approaching the system’s minimum power.

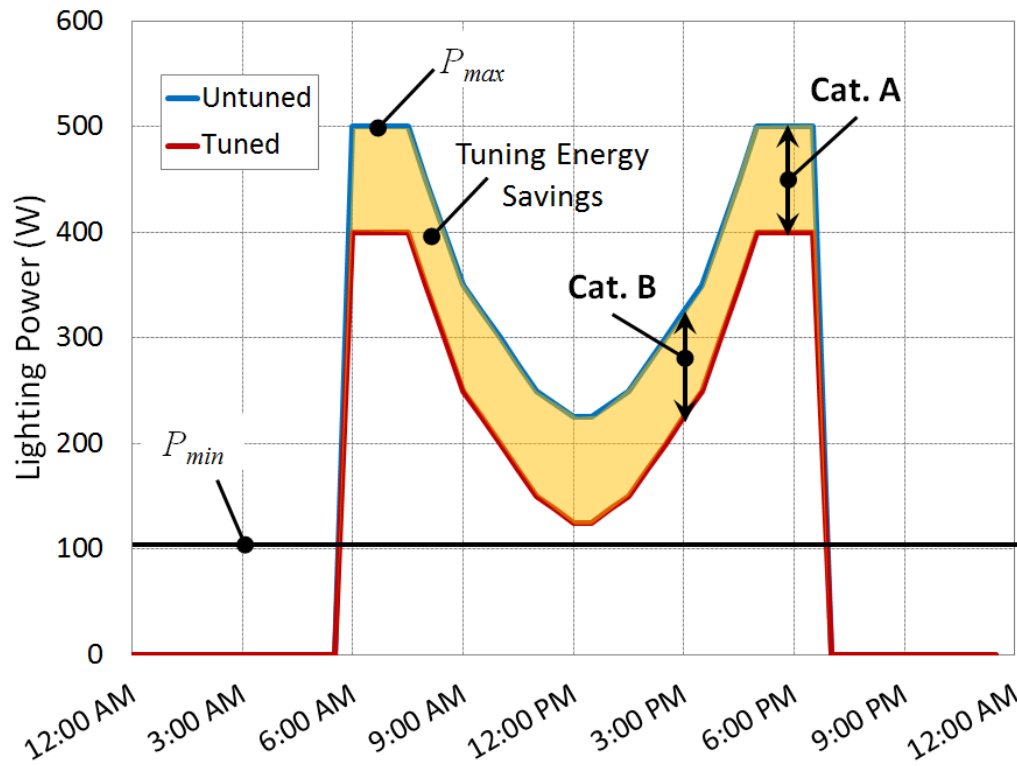

In this idealized case, the untuned lighting system is off overnight. When the first occupant arrives at 6:00 am, the lights come on to their untuned full power, P_{max} . When the sun rises at 8:00 am, the lights dim in response to the photosensor control detecting the available daylight illuminance. The lights continue to dim throughout the morning as the available daylight increases, and then increase in power as the daylight decreases over the afternoon. When the sun sets at 5:00 pm, the lights return to their full power. The lights remain at full power until the last occupant leaves for the evening at 7:00 pm, at which point they are shut off.

After tuning, the lighting system behaves in much the same manner as before. However, when the lights are on, they are at a lower power than before tuning. This power savings falls into two categories:

Category A: No photocontrol. During these periods, the power savings is equivalent to the power savings from a system without photocontrol. The savings are achieved by adjusting the lighting system’s high end trim. For example, before tuning the high end trim was set to 50 fc, while after tuning it was set to 40 fc.

Category B: With photocontrol. During these periods, the photocontrol is trying to meet a total illuminance setpoint that is lower than before tuning. For example, before tuning the photosensor setpoint was set to 50 fc, while after tuning it was set to 40 fc.

Both categories and their respective illuminance and energy savings are illustrated in Figure 15.

Figure 15: Example lighting system's power and illuminance savings from task tuning with photocontrol without approaching the system's minimum power.

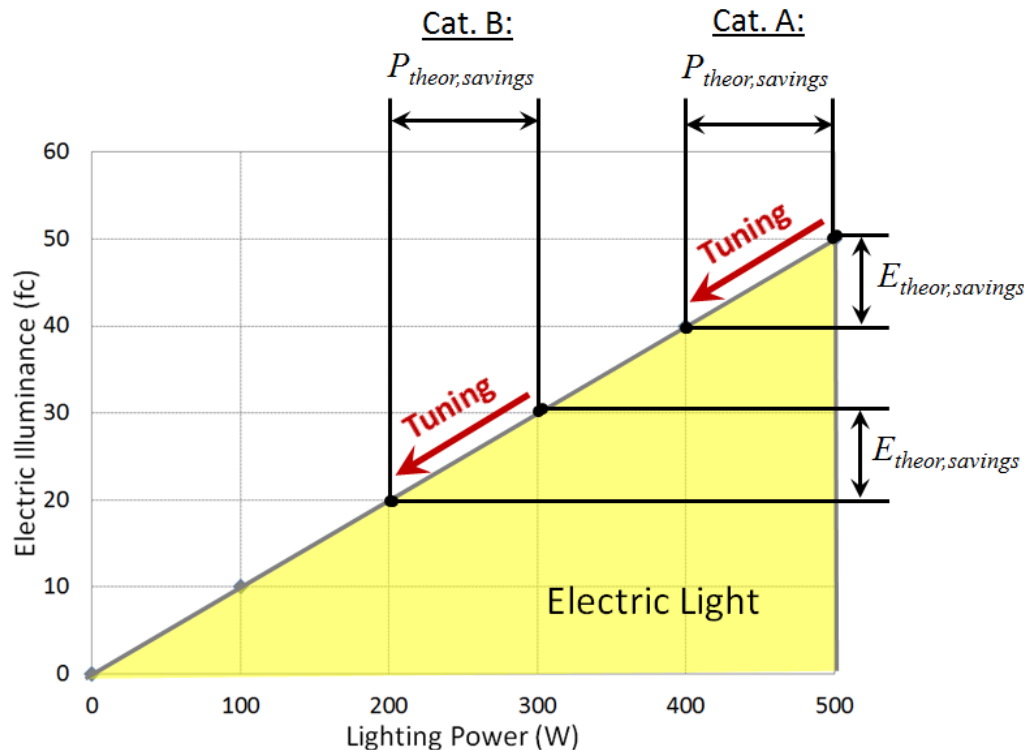

During periods of category A, the high end trim is reduced by 10 fc, from 50 fc to 40 fc. This reduction results in a power savings of 100 W, from 500 W to 400 W. These savings are equivalent to the savings described previously for a system without photocontrol.

During periods of category B, there is some amount of daylight illuminance present. For the example above, there is 20 fc of daylight illuminance. Before tuning, the photocontrol setpoint is 50 fc, meaning that the photocontrol system dims the lights to provide 30 fc of electric illuminance by using 300 W. After tuning, the photocontrol setpoint is 40 fc. Under the same 20 fc of daylight illuminance, the photocontrol system must now only provide 20 fc of electric illuminance, by using 200 W. This means that there is a power savings of 100 W. For systems with a linear relationship between illuminance and power, the power savings is the same between Category A and B. **This implies that the absolute energy savings from task tuning is independent of whether a system has photocontrol.**

There is one significant caveat to this implication. **The savings between Category A and B are not equivalent if task tuning would bring the system power below the system's minimum power.** Figure 16 illustrates this for the same typical day as our previous example.

Figure 16: Tuned and untuned lighting power for a system with photocontrol over a typical day that does approach the system's minimum power.

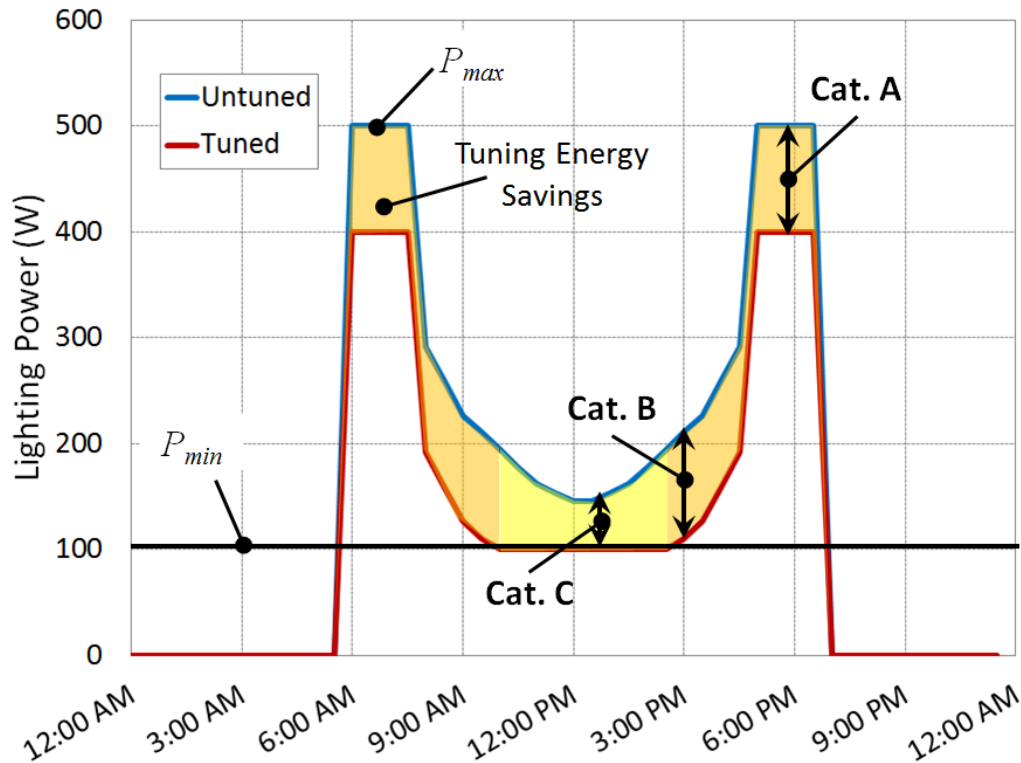

For the untuned lighting system, we see the same profile as before. However, in this scenario the daylight illuminance is high enough that the lighting system's power approaches its minimum. During these periods (shaded in yellow), the power savings from tuning deviates from the previous calculation. This situation defines a new category.

Category C: With Photocontrol, Near Minimum. During these periods the photocontrol is trying to meet a total illuminance setpoint that is lower than before tuning. However, in doing so, it is unable to reach the full lighting power reduction due to the lighting system's minimum power.

The subsequent calculations outline savings for a particular type of photocontrol, namely, systems that dim to some minimum power without shutting off. This is the type of control that we overwhelmingly found in our study. Categories B and C and their respective illuminance and energy savings are illustrated in Figure 17.

Figure 17: Example lighting system's power and illuminance savings from task tuning with photocontrol that does approach the system's minimum power

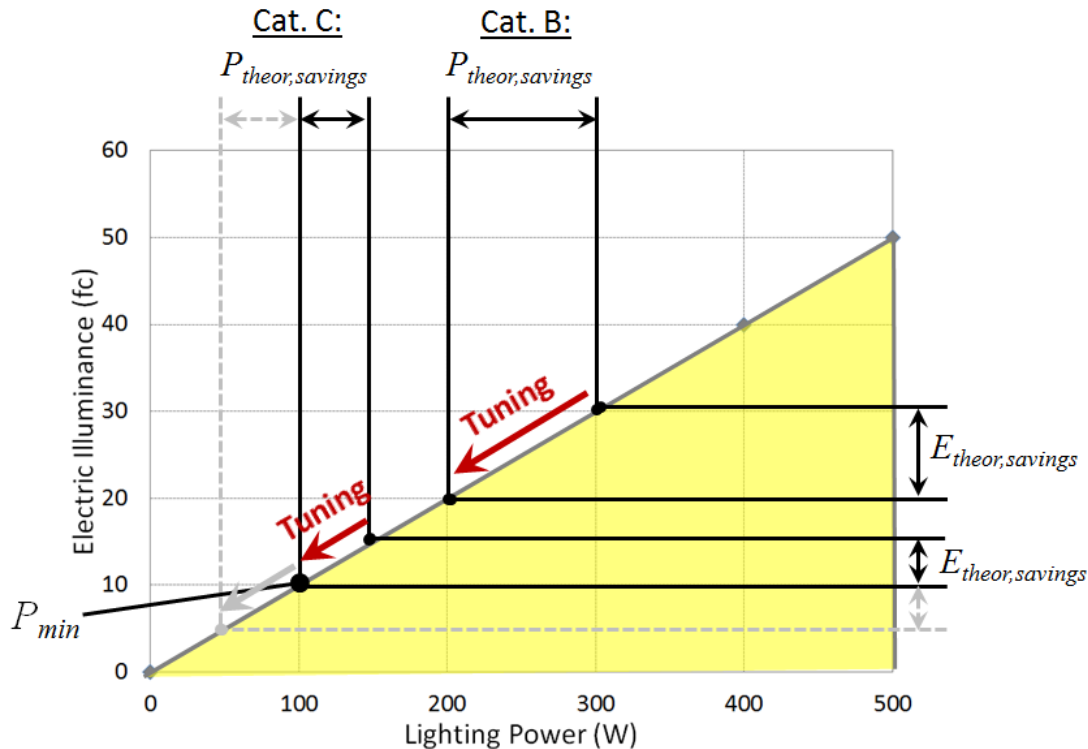

During periods of category C, there is a significant amount of daylight illuminance present. For the example above, there is 35 fc of daylight illuminance. Before tuning, the photocontrol setpoint is 50 fc, meaning that the photocontrol system dims the lights to provide 15 fc of electric illuminance by using 150 W. After tuning, the photocontrol setpoint is 40 fc. Under the same 35 fc of daylight illuminance, the photocontrol system would like to provide 5 fc of electric illuminance, by using 50 W. However, the system's minimum power is 100 W. So, it is unable to reduce the lights any further. This means that for this example, the savings is reduced from 100 W to 50 W. The deviation in power savings within this category is illustrated by the grey lines of Figure 17.

In understanding the implications of this category, it is useful to analyze it at its limit, which is a space with daylight illuminance well above the photosensor setpoint. How would our above example change if the available daylight was 50 fc or higher? In this instance, the lights would be dimmed to their minimum before tuning. After tuning, the lights would still be at their minimum. There would therefore be no savings from task tuning.

A similar phenomenon exists on the opposite end of the power spectrum. Since our theoretical calculations also addressed under lit systems, we accounted for the divergence in energy savings that "untuning" a system would cause when it attempts to exceed its maximum power.

The following section outlines the energy savings calculation for systems with photocontrol under the different categories outlined above.

Lights Off

The lights are considered off when the measured power is below the system's minimum power.

$$P_i < P_{min}$$

The illuminance savings from tuning is zero:

$$E_{theor,savings} = 0$$

The power savings from tuning is also zero.

$$P_{theor,savings} = 0$$

Categories A and B

Since these categories are equivalent with respect to savings, we outline their calculations together. These categories are defined by a measured power greater than or equal to the system's minimum power plus the maximum theoretical power savings.

$$P_i \geq P_{min} + (P_{untuned} - P_{tuned})$$

From this category the illuminance savings from tuning is:

$$E_{theor,savings} = E_{crit,untuned} - E_{crit,tuned}$$

The power savings from tuning is likewise calculated based on the illuminance savings and working plane illuminance-to-power curve slope.

$$P_{theor,savings} = \frac{E_{theor,savings}}{m}$$

Category C: With Photocontrol, Near Minimum

This category is defined by a measured power less than the system's minimum power plus the maximum theoretical power savings.

$$P_i < P_{min} + (P_{untuned} - P_{tuned})$$

From this category the illuminance savings from tuning is:

$$E_{theor,savings} = E_{crit,untuned} - E_{min}$$

Where:

E_{min} is the electric illuminance of the lighting system at its minimum power.

The power savings from tuning is.

$$P_{theor,savings} = P_i - P_{min}$$

Once the power savings for each time interval is known, the theoretical energy savings from task tuning is then calculated by summing the power savings over the hours that the lights are on in a given period.

$$W_{theor,savings} = P_{theor,savings} \cdot \tau_{on,j}$$

If the system had not already been tuned, the theoretical percent savings, $Savings_{theor,\%}$ is calculated by:

$$Savings_{theor,\%} = \frac{W_{theor,savings}}{W_{meas,j}}$$

If the system had already been tuned, the theoretical percent savings is calculated by:

$$Savings_{theor,\%} = \frac{W_{theor,savings}}{W_{meas,j} + W_{theor,savings}}$$

This accounts for the fact that the measured energy consumption in a tuned period does not include the energy from the tuning itself. The theoretical savings, $Savings_{theor,kWh/kWh}$ is calculated by:

$$Savings_{theor,kWh/kWh} = \left(\frac{W_{theor,savings}}{P_{max,dim}} \right) \left(\frac{\tau_{tot,ann}}{\tau_{tot,j}} \right)$$

Energy Savings Interactivity

Through a similar set of calculations, we could address the following interesting questions.

- What is the interactivity between photocontrol and task tuning?
- Alternately, what would the task tuning savings have been had there not been photocontrol on a given system?

In the previous section, we developed theoretical energy savings estimates from task tuning. *For the subset of systems that had photocontrol, these estimates defined the energy savings from task tuning after photocontrol. In order to understand the interactivity between photocontrol and task tuning, we needed to develop theoretical energy savings from task tuning for these same systems had they not had photocontrol.* We could then compare the two savings estimates to draw conclusions as to the magnitude of this interactivity.

Figure 18 illustrates the different situations involved in this calculation.

Figure 18: Tuned and untuned lighting power for the same system both with and without photocontrol.

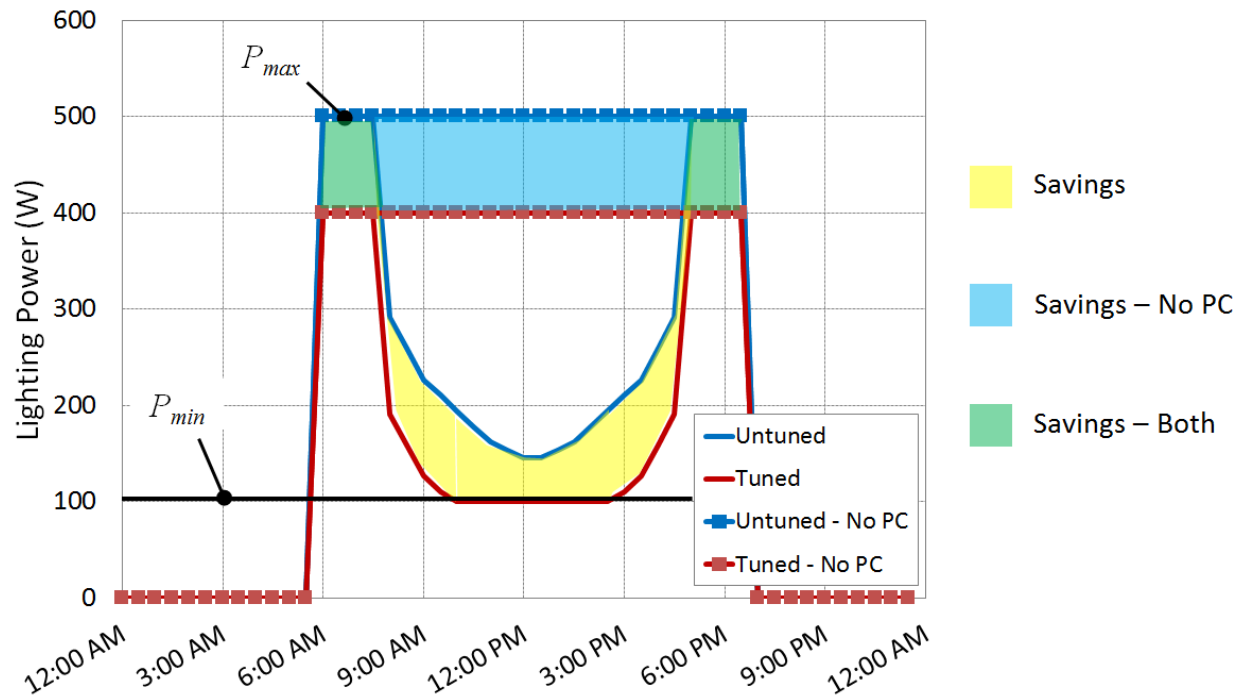

For this example, we chose a system with photocontrol that approaches its minimum power. This system is the same as the one depicted in Figure 16. The blue line shows the untuned lighting power of this system. The red line is this same system after tuning. The yellow shading is the energy savings from task tuning with photocontrol.

We then had to define how the system would behave if it did not have photocontrol. For any time interval for which the untuned measured power was above the system’s minimum power (i.e. the lights were on), we assumed that the measured power without photocontrol, $P_{nopc,i}$ was the system’s full power.

$$P_{nopc,i} = \begin{cases} 0, & P_i < P_{min} \\ P_{max}, & P_i \geq P_{min} \end{cases}$$

This new measured power is illustrated in Figure 18 by the blue squares. This curve is equivalent to Category A, meaning that the illuminance savings from tuning without photocontrol, $E_{theor,nopc,savings}$ is:

$$E_{theor,nopc,savings} = E_{crit,untuned} - E_{crit,tuned}$$

The power savings from tuning without photocontrol, $P_{theor,nopc,savings}$ is likewise calculated based on the illuminance savings and working plane illuminance-to-power curve slope.

$$P_{theor,nopc,savings} = \frac{E_{theor,nopc,savings}}{m}$$

In Figure 18, the red squares depict this situation, and bound the blue shading, which is the energy savings from task tuning without photocontrol. The green shading depicts energy

savings associated with both photocontrol and no photocontrol. The theoretical savings, $Savings_{theor,nopc,kWh/kW}$, is calculated by:

$$Savings_{theor,nopc,kWh/kW} = \left(\frac{W_{theor,nopc,savings}}{P_{max,dim}} \right) \left(\frac{\tau_{tot,ann}}{\tau_{tot,j}} \right)$$

We did not calculate percent savings for this category, as it would be based on a different absolute energy consumption (that of a system always at its full power). It would therefore not be comparable to the situation of a system with photocontrol.

Data Quality Control

Data accuracy is of primary importance to ensure that results are useful to the design and research community, replicable by other researchers, and admissible for utility program design, calculations, and evaluation. This level of accuracy begins with quality measurements; in this case measurement tools were calibrated as discussed in the Methodology and Analysis section. Beyond the steps we took to calibrate our measurement tools, we also addressed the circumstances under which the measurements were taken and how we subsequently used them.

Much of our work relies primarily and directly on measuring the current of the lighting systems studied and the associated electric illuminance. Energy savings in all its forms, for example, is based almost solely on these measurements. We did not have any significant inaccuracies in the measurement of illumination itself, but the various uses of those light measurements were subject to more potential uncertainty. We attempted to mitigate this uncertainty in several ways.

First, both the critical workplane illuminance measurements and determination of average illuminance level were subject to potential errors. We therefore followed best practices when taking these measurements including:

- Waiting for the lights to warm up before taking measurements.
- Standing away from the light meter when possible. If not possible, holding it well away from our body so as not to shield any light.
- Taking “lights on” measurements followed immediately by “lights off” measurements. This minimized the chance of daylight illuminance changing significantly between measurements, as well as measurement inaccuracies related to lights warming up.
- Repeating a subset of measurements to check for consistency between measured values.

Once the data was collected, we visually inspected it for realistic behavior such as:

- Significant gaps
- Reduced power during the day for photocontrolled systems
- Maximum measured power consistent with our estimate for the system’s total installed power
- Minimum power consistent with our estimate for the system’s minimum power
- Reduced full power between period 1 and period 2 for spaces that we tuned

We also performed a sanity check on our energy savings estimates and either corrected issues that were identified or developed reasonable explanations for them.

- Did our energy savings estimates agree with similar published research?
- Did the spaces with higher percentage reduction also have higher percent savings?
- Did the spaces with photosensor control have lower savings than those that did not?
- Did the spaces with longer hours of operation exhibit higher kWh/kW savings?
- For the spaces that we didn't tune, were the theoretical percent savings between periods in relatively good agreement?
- Does the difference in theoretical savings between the IESNA and occupant preferred illuminance levels make sense?
- Is there relatively good agreement between the measured and theoretical energy savings?
- Is the kWh/kW savings lower than the number of hours that the lights were on?

Extrapolation Methodology

In order to extrapolate Minnesota's statewide potential for energy savings from task tuning we extended the findings from our study to the larger population of related commercial buildings within the state. We used data from the Commercial Building Energy Consumption Survey (CBECS), the U.S. Census and Minnesota weather data, as well as our measured results, to model lighting energy use and potential savings from task tuning for four building sectors. Three of the building sectors were studied as part of this project; Education, Office, and Public Assembly. The fourth, Warehouse/Storage, was identified during our literature review as having a high potential for task tuning energy savings. We did not include retail as part of this extrapolation despite its high potential for task tuning energy savings. Typically retail owners tend to believe that lowering light levels on their merchandise will adversely affect product sales, thus would be reticent to implement task tuning.

We found aggregate electricity consumption data for our four building sectors from the 2003 CBECS (EIA c 2003). Because the CBECS electricity consumption data was over a decade older than the data from our study we assumed a 10 percent increase in consumption to establish an estimate for 2014, the year of our study. We arrived at this number by analyzing the growth of floor space between these periods (EIA d 2003) (EIA e 2003).

Next, we broke out Minnesota consumption data from the total for the West North Central region using population data from the U.S. Census (Census 2013). Minnesota accounted for 26 percent of the population of the West North Central region and we assumed electricity consumption in Minnesota when compared to the region scaled in proportion with population.

We built representative building energy models for each building type using DOE2 with eQuest as a front end. Year-long simulations incorporating typical Minnesota weather were used to estimate the percentage of total building electricity consumption that can typically be attributed to lighting for each building type. We then assumed that 50 percent of the lights in these buildings would be tunable. This conservative assumption was based on our experience from both this study and designing lighting systems for commercial buildings. The ancillary space types that are not likely to be effectively tuned within the context of a CIP include corridors, support areas such as printer rooms, storage spaces and restrooms.

We further assumed utility efficiency programs could apply task tuning to 1.5 percent of the buildings within each sector. This penetration rate was based on capturing 50 percent of new

construction (assumed to account for approximately 1 percent of commercial buildings in Minnesota), and approximately 1 percent of existing buildings. These assumptions are in line with typical market penetration rates found in a recent market potential study (Kema 2012). We then applied these assumptions to our estimates of commercial building electricity consumption in Minnesota, allowing us to estimate the amount of tunable lighting energy in Minnesota.

Finally, the results of our study show that task tuning would reduce lighting electricity consumption by 22 percent on average. We applied this reduction to the previous estimates to calculate the electricity savings from task tuning in Minnesota. This value was converted to dollar savings using an average electric utility rate of \$0.097/kWh (EIA f 2015). We used conversions outlined in ASHRAE Standard 105-2014 to estimate greenhouse gas emissions saved in metric tons CO₂ equivalent (ASHRAE 2014).

Results

The primary objective of this research is demonstrating the impact of task tuning on the performance of dimmable lighting systems. In the previous sections we discussed how we developed the metrics to demonstrate this impact, including measured and theoretical energy savings, as well as a method for understanding the interactivity between photocontrol and task tuning. Following are the results of those calculations.

Measured Energy Savings Results

Measured data was collected to determine the performance of each tuned system. As shown in Figure 8, we identified seven systems that were over lit based on IESNA recommendations. We tuned all seven of those systems. In three spaces (Comp 3, O Off 3 and Conf 2) that we identified as under lit in comparison to IESNA recommendations, occupants indicated that they preferred even lower light levels (essentially redefining these under lit systems as over lit). We tuned those three systems to the light levels requested by the occupants. From these ten tuned systems, we have results for only seven. We were unable to calculate energy savings for two of the systems (Stack and Study) because one of our monitoring periods experienced a data acquisition error. The other system (Conf 2) is addressed separately in the Conference Room Case Study section. The primary metrics used to describe performance are electricity savings per dimmable lighting power in units of kWh/kW and the percentage of energy saved for the controlled lighting. These primary metrics are summarized in Table 5 by space. Median values for the study are shown in Table 6. Note that for five of the spaces, the tuned light levels reflect the IESNA recommendations, while the other two were tuned to the occupant preferences.

Table 5: Primary metrics describing the measured energy savings from tasking tuning.

| ID | Space Description | Percentage Reduction | | Savings | |
|---------|-------------------|----------------------|---------------------|---------|----------|
| | | IESNA Recommended | Occupant Preference | (%) | (kWh/kW) |
| O Off 2 | Open Office | 24% | | 36% | 1662 |
| Comp 2 | Computer Lab | 32% | | 32% | 802 |
| Comp 1 | Computer Lab | 38% | | 26% | 587 |
| Bar | Bar | 25% | | 21% | 286 |
| O Off 3 | Open Office | | 15% | 20% | 623 |
| Class | Classroom | 15% | | 15% | 194 |
| Comp 3 | Computer Lab | | 15% | 5% | 136 |

The measured data shows that the average savings from task tuning was approximately 613 kWh for every kW of lighting that was dimmable, or about 22 percent of the dimmable lighting energy.² If we look at the units of kWh/kW, this essentially simplifies to the number of

² It is useful to benchmark the results against the most similar studies completed. A metastudy of lighting control research (Williams 2012) shows 36 percent measured savings from tuning across a set of 13 offices.

equivalent hours in a year for which the lights would be fully off. If a typical commercial space operates for 3,500 hours per year, it seems reasonable that task tuning could essentially keep the lights off for nearly one-fifth of the time. On a per square foot basis, for a typical commercial space lit with 1 W/ft², this savings equates to 0.6 kWh/ft².

Table 6: Range of savings for tuned spaces

| | Percentage Reduction | Savings | |
|---------|----------------------|---------|----------|
| | | (%) | (kWh/kW) |
| Average | 23% | 22% | 613 |
| Median | 24% | 21% | 587 |
| Minimum | 15% | 5% | 136 |
| Maximum | 38% | 36% | 1662 |

Savings ranged from as high as 36 percent or 1,662 kWh/kW of dimmable lighting in a highly over lit office with relatively long hours of operation, to as low as 5 percent or 136 kWh/kW of dimmable lighting in a computer lab with relatively short hours of operation and not strongly over lit. There was a somewhat uniform distribution of energy savings across the measured spaces (see Figure 19).

Figure 19: Distribution of measured tuning savings (by %) for the sample of spaces.

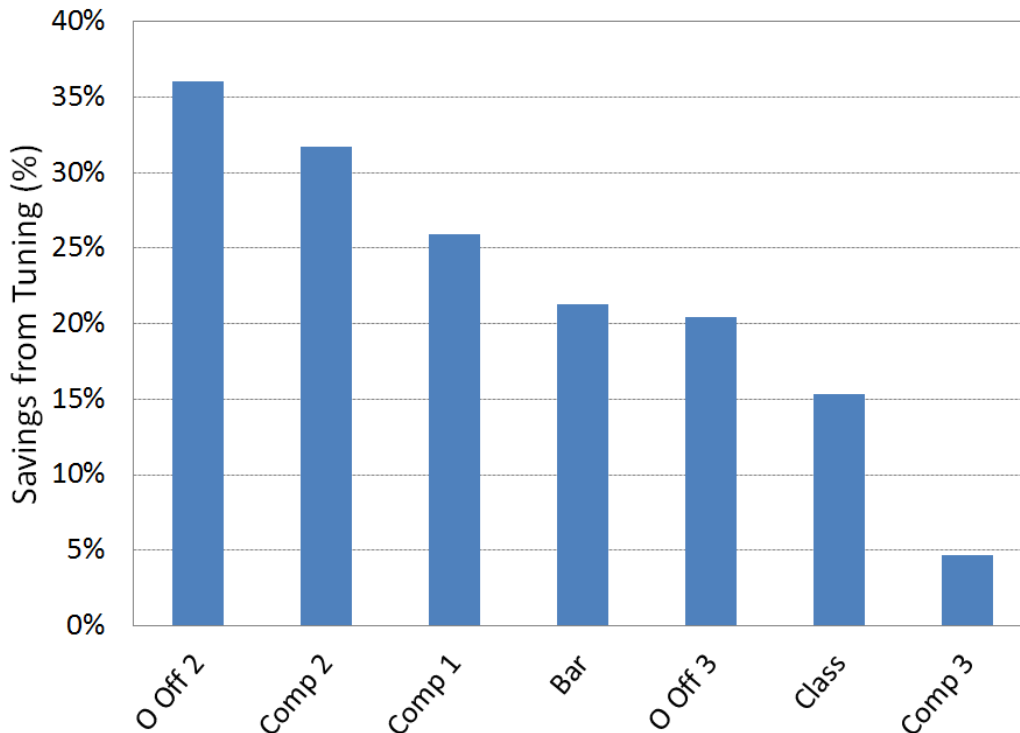

It is difficult to discern the reason behind our lower savings, but potential reasons could be decreased savings due to photocontrol or differing space types.

Although the spaces are still sorted from highest to lowest percent savings, Figure 20 shows a less uniform distribution of energy savings in terms of kWh/kW.

Figure 20: Distribution of measured tuning savings (by kWh/kW) for the sample of spaces.

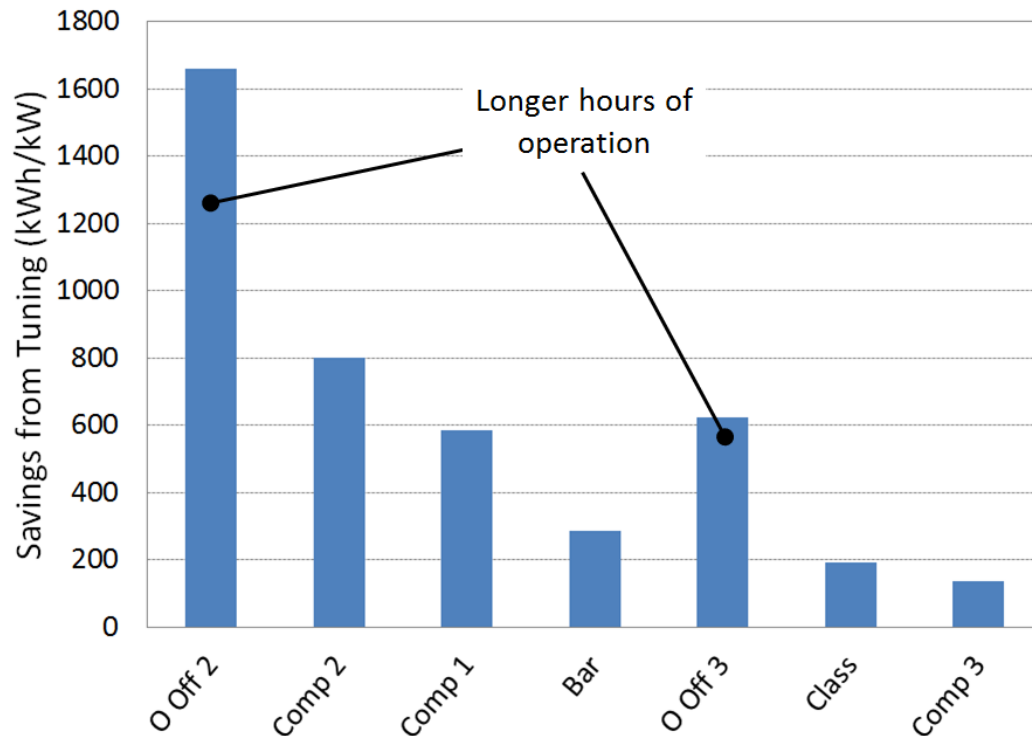

The two offices stand out as having higher kWh/kW savings due to their longer hours of operation as compared to the computer labs and bar.

Conference Room Case Study

One of the conference rooms (Conf 2) is worth discussing in more depth, due to the interesting effect that task tuning had on the system's measured lighting energy consumption. The space is a conference room in an office building, and is used for meetings and presentations. The lighting system in this space is comprised of 5 three lamp, fluorescent T5 fixtures for ambient illumination over the main conference table and 12 LED downlights around the perimeter. The lights are controlled by a wall mounted digital scene controller. This controller's capabilities include allowing an occupant to manually dim the lights or select from a set of pre-defined scenes of varying lighting levels. The system also includes an occupant sensor that will turn off the lights if no occupants are detected in the space. Both the space and controller are shown in Figure 21.

Figure 21: Conference room and associated digital controller.



Figure 22: Lighting power profile of conference room before tuning.

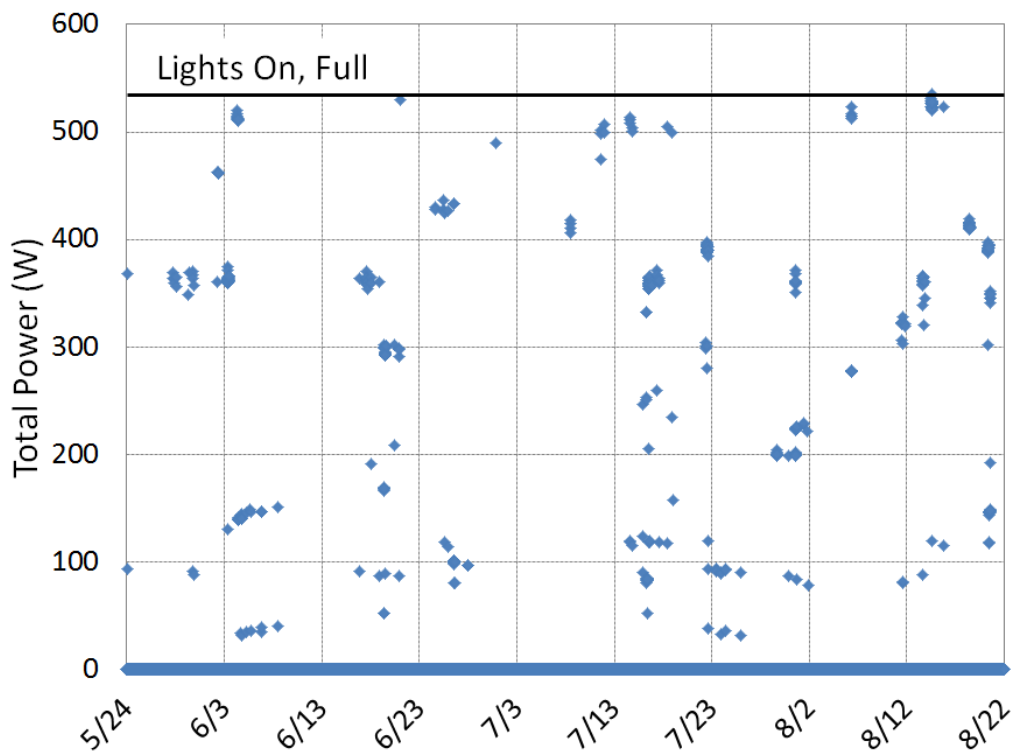

Before tuning, the controller had no pre-defined scenes. An occupant could either turn any of three zones (front fluorescents, back fluorescents, and LEDs) on or off, or dim the lights for a given zone using an associated slider. When the lights were turned on, they came on to the dimmed setting from the previous occupant. This configuration led to the lighting power profile shown in Figure 22.

Note the sporadic and varied usage profile, with lights coming on at different times of the day and at different power levels. Also of interest is the clustering of lighting power, as occupants use the same settings as the previous occupants, without adjusting the lights to their own preferred levels.

Before tuning, the average illuminance of the room was measured to be 34 fc, while the IESNA recommendations for a conference room are 30 fc. Although the space was only slightly over lit, the lighting designer for the space, who was also an occupant, was interested in reducing the average illuminance to 20 fc. However, he was concerned about reducing the perimeter lighting, as it accented the walls. This system did not have the high end trim setting typically adjusted during tuning. Instead, we set up a pre-defined scene that allowed an occupant to turn the lights on to the appropriate, tuned lighting level. However, to not lose light on the walls, this scene only dimmed the linear fluorescents and not the perimeter LEDs. It therefore equated to a total power reduction of 28 percent or a total lighting power of approximately 390 W. The occupants still had the option of dimming a given zone to their individual preference. This new configuration led to the lighting power profile shown in Figure 23.

Figure 23: Lighting power profile of conference room after tuning.

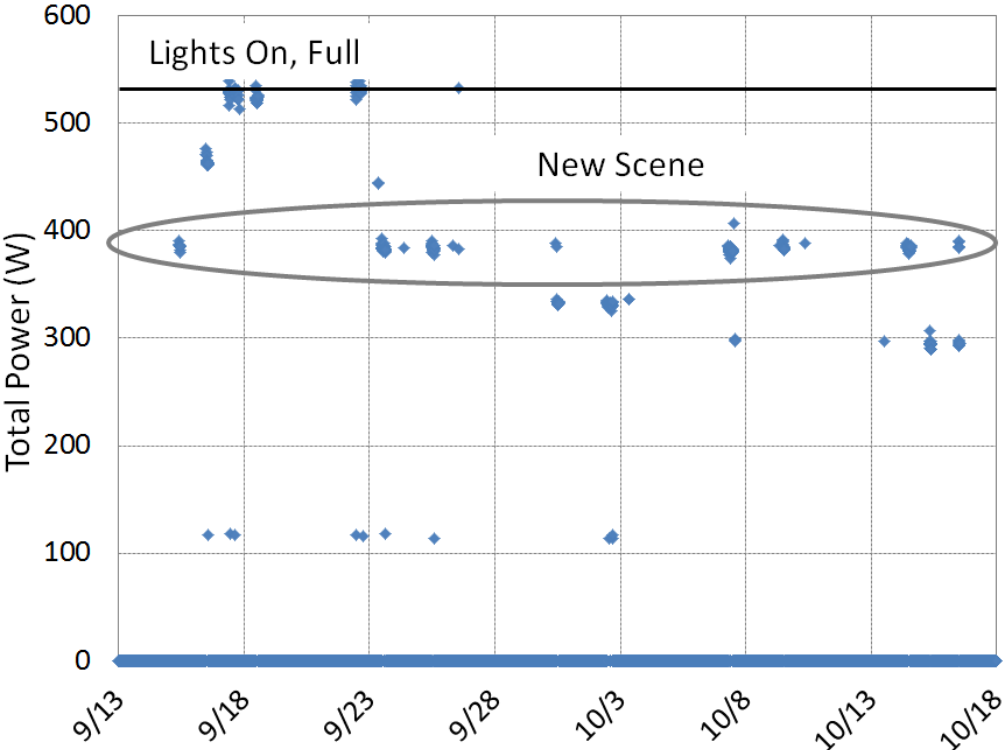

The usage profile continued to be sporadic and varied, with lights coming on at different times of the day and at different power levels. However, the new scene is clearly evident at power

consumption around 390 W. This is even more apparent in Figure 24, which shows the percentage of time that the lights are on within a given range of power.

Figure 24: Percent of time spent in a given power range both before and after tuning.

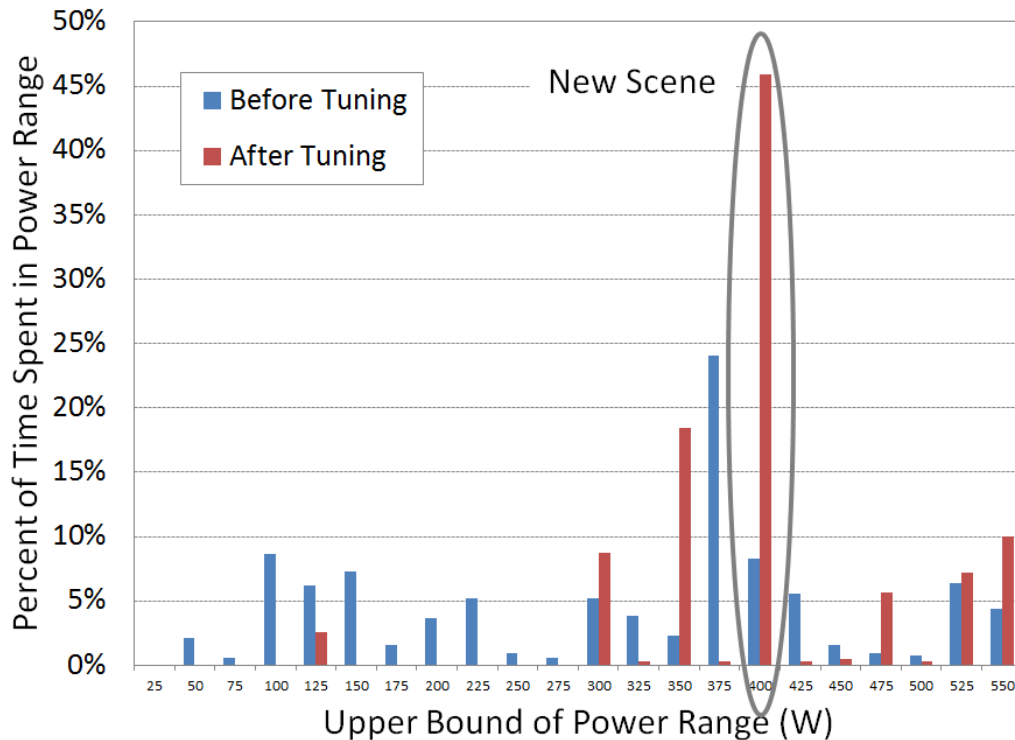

Before tuning, the occupants chose a variety of lighting powers based on their individual preferences and presentation needs. After tuning, the occupants tend to select the pre-defined scene. Although the pre-defined scene is lower than the full power of the system, it did not result in a reduction in lighting energy. This is because, when they didn't have a scene to select, the occupants tended to reduce the lights lower than the light levels associated with the scene. However, given the convenience of selecting the scene, they more often selected this option as opposed to adjusting the light levels manually. In fact, lighting energy consumption actually increased by 4 percent due to the creation of this scene. *Although scenes can be used to task tune the lighting systems in conference rooms, care should be taken as occupant behavior can cancel any expected lighting savings.*

Theoretical Energy Savings Results

Theoretical energy savings were developed in addition to the measured energy savings detailed previously. The same primary metrics are used as with the measured savings estimates; electricity savings per dimmable lighting power in units of kWh/kW and the percentage of energy saved for the controlled lighting. These primary metrics are summarized in Table 7 by space for tuning to recommended light levels, with median values for the over lit spaces in the study highlighted at the bottom.

Table 7: Primary metrics describing the theoretical energy savings from tasking tuning to recommended lighting levels.

| | ID | Space Description | Percentage Reduction | Savings | |
|---------------------------------------|---------|------------------------|----------------------|---------|----------|
| | | | Recommended | (%) | (kWh/kW) |
| Over lit | O Off 2 | Open Office | 62% | 48% | 2910 |
| | Bar | Bar | 46% | 36% | 509 |
| | Comp 1 | Computer Lab | 38% | 35% | 833 |
| | Comp 2 | Computer Lab | 32% | 32% | 1148 |
| | Stack | Library Stacks | 39% | 26% | 1380 |
| | Class | Classroom | 15% | 14% | 312 |
| | Study | Study Area | 17% | 9% | 1558 |
| Neutral | Trans | Transportation Waiting | 1% | 2% | 121 |
| Under lit | Conf 1 | Conference | -6% | -12% | -58 |
| | Conf 2 | Conference | -16% | -20% | -43 |
| | Train | Training Room | -29% | -30% | -150 |
| | O Off 4 | Open Office | -41% | -30% | -526 |
| | O Off 1 | Open Office | -33% | -56% | -233 |
| | Comp 3 | Computer Lab | -48% | -73% | -1243 |
| | P Off | Private Office | -121% | -87% | -420 |
| | Conf 3 | Conference | -32% | -101% | -131 |
| | O Off 3 | Open Office | -51% | -124% | -1390 |
| Summary Statistics³ | | | | | |
| Average | | | 36% | 29% | 1236 |
| Median | | | 38% | 32% | 1148 |
| Minimum | | | 15% | 9% | 312 |
| Maximum | | | 62% | 48% | 2910 |

Savings for over lit spaces ranged from as high as 48 percent or 2,910 kWh/kW of dimmable lighting to as low as 9 percent or 312 kWh/kW of dimmable lighting.

These same metrics are summarized in Including occupant feedback in the tuning process increased theoretical savings in these spaces on average from 149 to 673 kWh/kW. This is due to the fact that, on average, occupants preferred lighting levels below IESNA recommendations.

Table 8 by space for tuning to occupant preferred light levels, with median values for the over lit spaces in the study highlighted at the bottom. Note that results for Stack are not available due to the previously mentioned data acquisition error.

³ The summary statistics are for the seven over lit spaces only. The theoretical estimates show that the average savings from task tuning of the over lit spaces was approximately 1,236 kWh for every kW of lighting that is dimmable, or about 29 percent of the dimmable lighting energy. On a per square foot basis, for a typical commercial space lit with 1 W/ft², this savings equates to 1.2 kWh/ft².

Including occupant feedback in the tuning process increased theoretical savings in these spaces on average from 149 to 673 kWh/kW. This is due to the fact that, on average, occupants preferred lighting levels below IESNA recommendations.

Table 8: Primary metrics describing the theoretical energy savings from tasking tuning to preferred lighting levels.

| ID | Space Description | Percentage Reduction | | Savings (%) | | Savings (kWh/kW) | |
|---------------------------|-------------------|----------------------|-----------|-------------|-----------|------------------|-----------|
| | | Recommended | Preferred | Recommended | Preferred | Recommended | Preferred |
| O Off 2 | Open Office | 62% | 24% | 48% | 38% | 2910 | 1927 |
| Bar | Bar | 46% | 25% | 36% | 24% | 509 | 276 |
| Conf 2 | Conference | -16% | 40% | -20% | 29% | -43 | 105 |
| Comp 3 | Computer Lab | -48% | 15% | -73% | 17% | -1243 | 603 |
| O Off 3 | Open Office | -51% | 15% | -124% | 15% | -1390 | 456 |
| Summary Statistics | | | | | | | |
| Average | | -1% | 24% | -26% | 24% | 149 | 673 |
| Median | | -16% | 24% | -20% | 24% | -43 | 456 |
| Minimum | | -51% | 15% | -124% | 15% | -1390 | 105 |
| Maximum | | 62% | 40% | 48% | 38% | 2910 | 1927 |

There was a somewhat uniform distribution of theoretical energy savings across all of the spaces (see Figure 25).

Figure 25: Distribution of theoretical tuning savings (by %) for the sample of spaces.

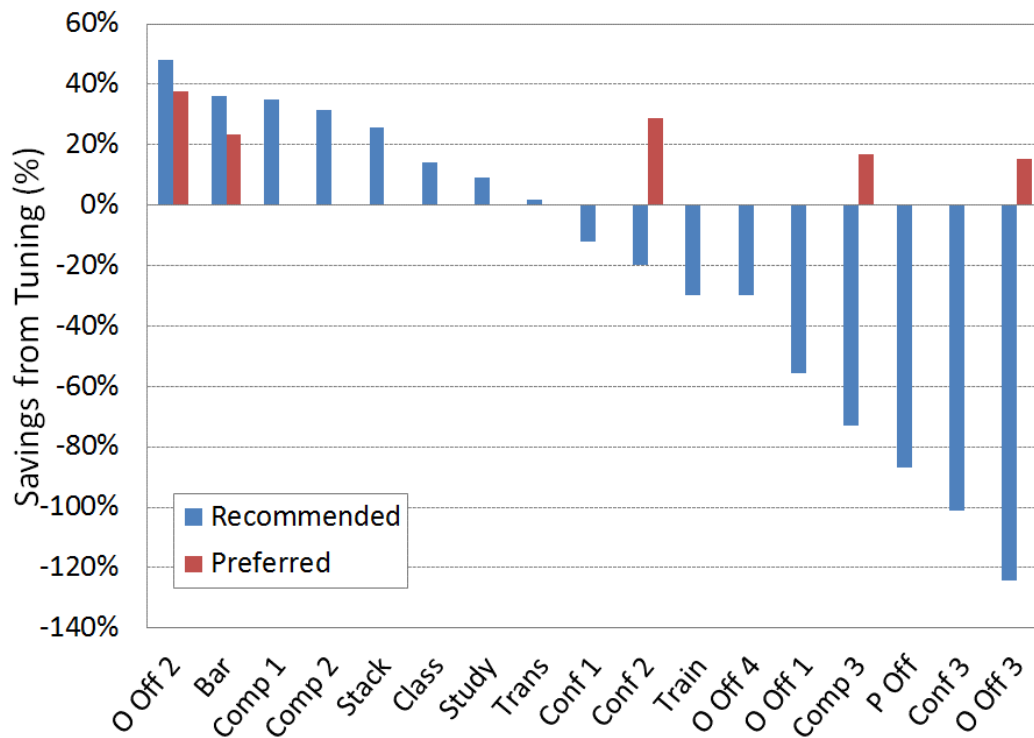

Although the spaces are still sorted from highest to lowest percent savings, Figure 26 shows a less uniform distribution of energy savings in terms of kWh/kW as spaces with longer operating hours have higher savings than their peers with similar over lit percentages.

Figure 26: Distribution of theoretical tuning savings (by kWh/kW) for the sample of spaces.

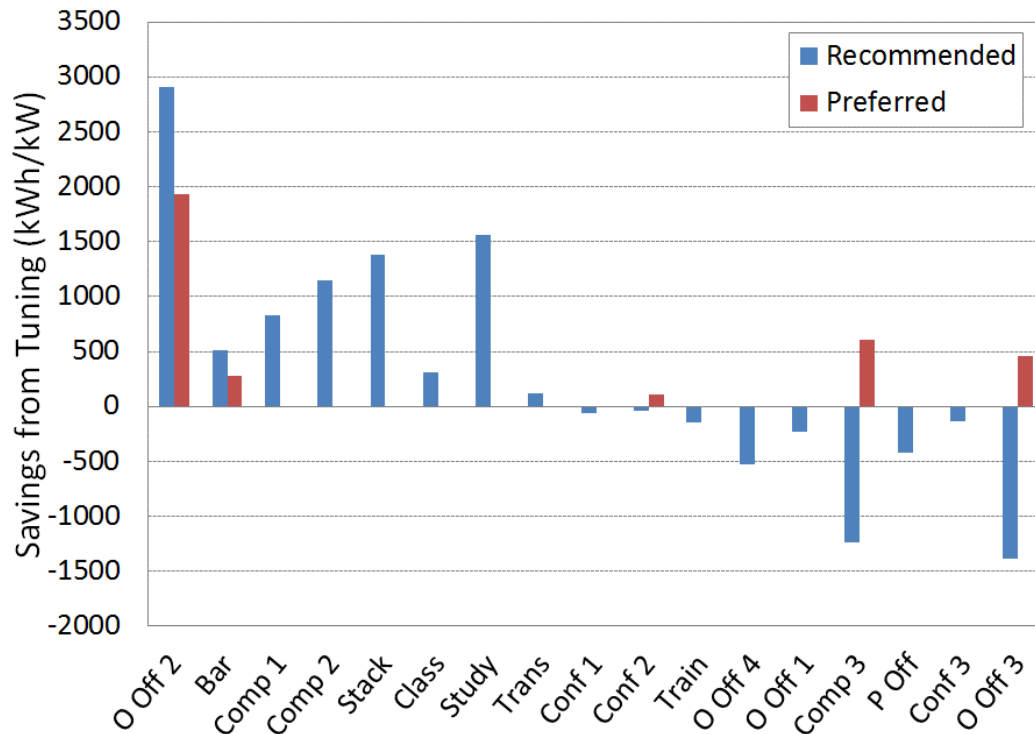

It is important to understand the agreement between the measured and theoretical energy savings. Table 9 outlines both for the tuned spaces for which we had data.

Table 9: Measured and theoretical energy savings.

| ID | Space Description | Savings (%) | | Savings (kWh/kW) | |
|---------|-------------------|-------------|-------------|------------------|-------------|
| | | Measured | Theoretical | Measured | Theoretical |
| O Off 2 | Open Office | 36% | 38% | 1662 | 1927 |
| Comp 2 | Computer Lab | 32% | 32% | 802 | 1148 |
| Comp 1 | Computer Lab | 26% | 35% | 587 | 833 |
| Bar | Bar | 21% | 24% | 286 | 276 |
| O Off 3 | Open Office | 20% | 15% | 623 | 456 |
| Class | Classroom | 15% | 14% | 194 | 312 |
| Comp 3 | Computer Lab | 5% | 17% | 136 | 603 |

For the theoretical calculations the occupant preferred light levels were used as opposed to the recommended light levels where applicable. Figure 27 illustrates the correlation between measured and theoretical energy savings in terms of kWh/kW.

Figure 27: Theoretical versus measured energy savings (by kWh/kW).

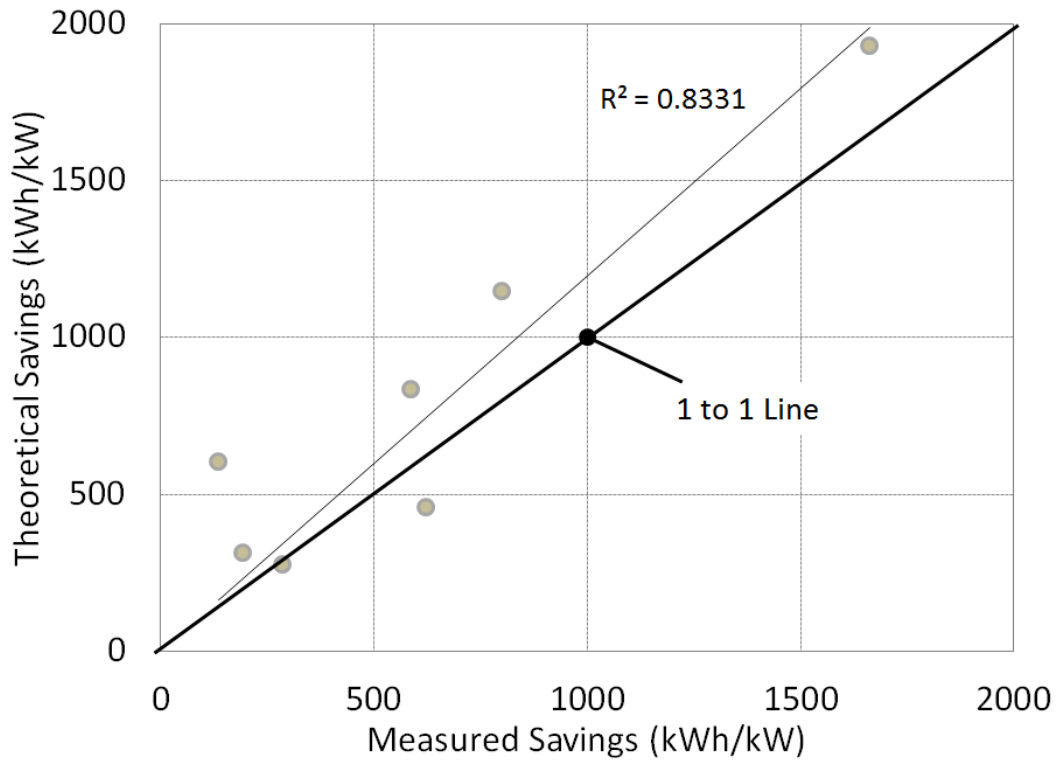
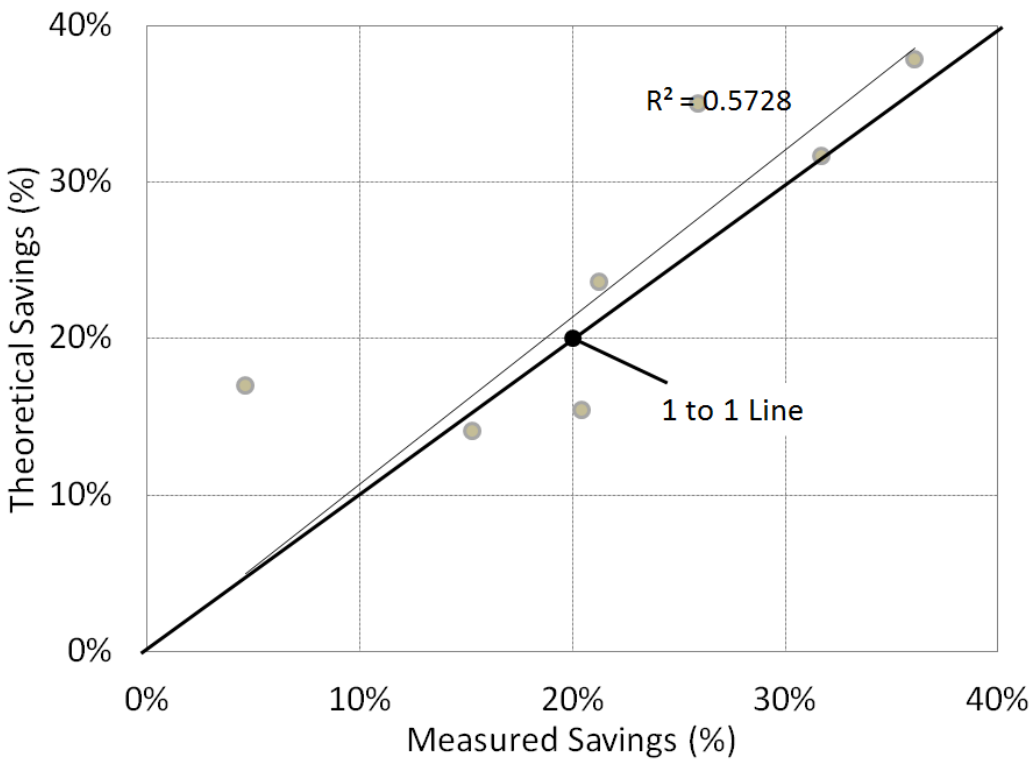

Figure 28: Theoretical versus measured energy savings (by %).



The theoretical savings estimates have a reasonable coefficient of determination with the measured savings of 0.83. However, they tend to overestimate the energy savings, falling routinely above the 1 to 1 line. On average, they overestimate the energy savings by 181 kWh/kW. Figure 28 illustrates the correlation between measured and theoretical energy savings in terms of percent.

Although the coefficient of determination is much lower (0.57), the general correlation is strong, without significant under- or over-prediction. The lower coefficient of determination is based on a single outlier.

Energy Savings Relationships

Now that we've established that the theoretical calculations are reasonable, we can explore some of the questions that they can be used to answer. To begin, we used the expanded set of theoretical energy savings to understand the relationship defining areas of potential savings from task tuning. The energy savings outlined in this section are the theoretical savings with respect to IESNA recommendations for all the spaces, including those that were under lit. Note that the number of spaces included in this analysis is too small to draw any statistically significant conclusions. The results therefore are more indicative of trends as opposed to definitive relationships.

Level of Commissioning

Figure 29: Average theoretical energy savings (in kWh/kW) for varying commissioning approaches.

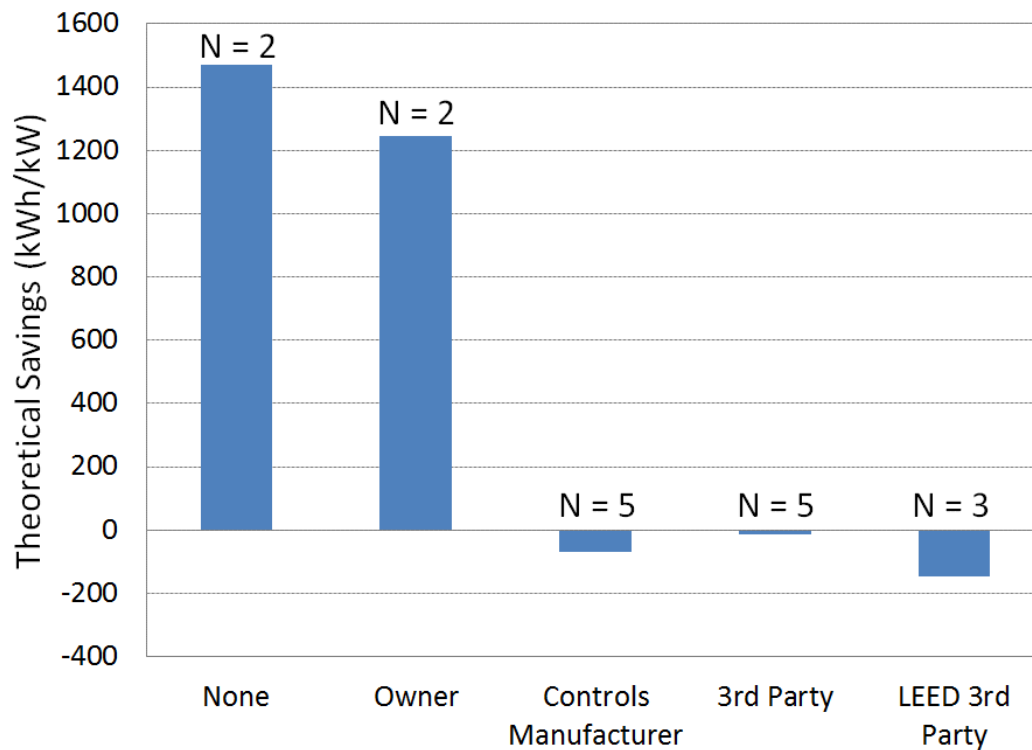

From our preliminary characterization, we know the general level of commissioning for each system. Figure 29 outlines the average theoretical energy savings from task tuning for various commissioning approaches.

High levels of potential energy savings from task tuning tend to correlate with no commissioning or commissioning by the owner. Systems that had been commissioned by a controls manufacturer, third party or LEED third party tended to have light levels more in line with recommended levels, resulting in lower levels of potential savings.

Level of Lighting Design

From our preliminary characterization, we know the general level of lighting design for each system. Figure 30 outlines the average theoretical energy savings from task tuning for various levels of lighting design.

Figure 30: Average theoretical energy savings (in kWh/kW) for varying levels of lighting design.

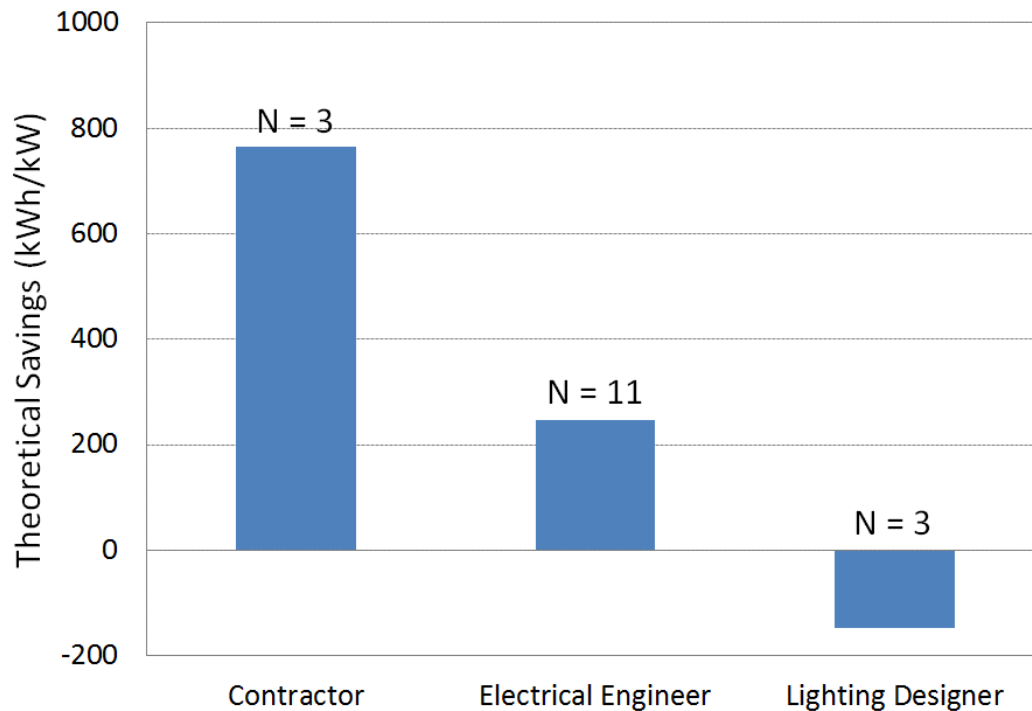

High levels of potential energy savings from task tuning tend to correlate with systems designed by a contractor. Systems that were designed by an electrical engineer had a lower potential for energy savings. Systems designed by lighting designers tended to have lighting levels near to or slightly below recommended levels, resulting in no potential for task tuning savings. This is likely due to additional design time spent selecting and laying out fixtures to target specific light levels area by area, combined with their higher level of design detail, including photometric calculations. In addition, their integration into the design process affords them the opportunity to collaboratively identify light level requirements. Taken together, this

results in spaces with measured light levels in close agreement to either IESNA recommendations or the owner's unique targets.

Building Type

From our preliminary characterization, we know the building type for each system. Figure 31 outlines the average theoretical energy savings from task tuning for various building types.

Figure 31: Average theoretical energy savings (in kWh/kW) for varying building types.

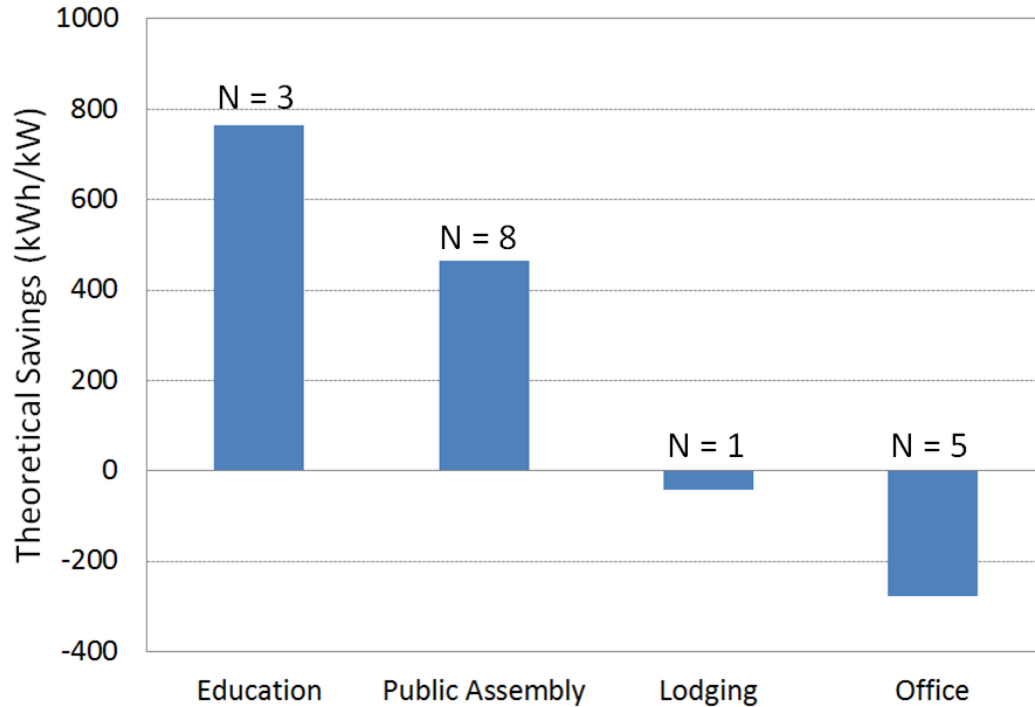

High levels of potential energy savings from task tuning tend to correlate with systems in education and public assembly buildings. Systems in the one building classified as lodging had negligible potential for savings. Although the systems in offices tended to show negative savings, this is likely due to our sample set having a disproportionate number of high performing offices. For example three of the five systems in offices were in buildings with a LEED Platinum rating.

Photocontrol

From our preliminary characterization, we know whether or not the system is controlled by a photosensor. Figure 32 shows the average theoretical energy savings from task tuning for systems with photocontrol and systems without photocontrol.

Figure 32: Average theoretical energy savings (in kWh/kW) for systems with or without photocontrol.

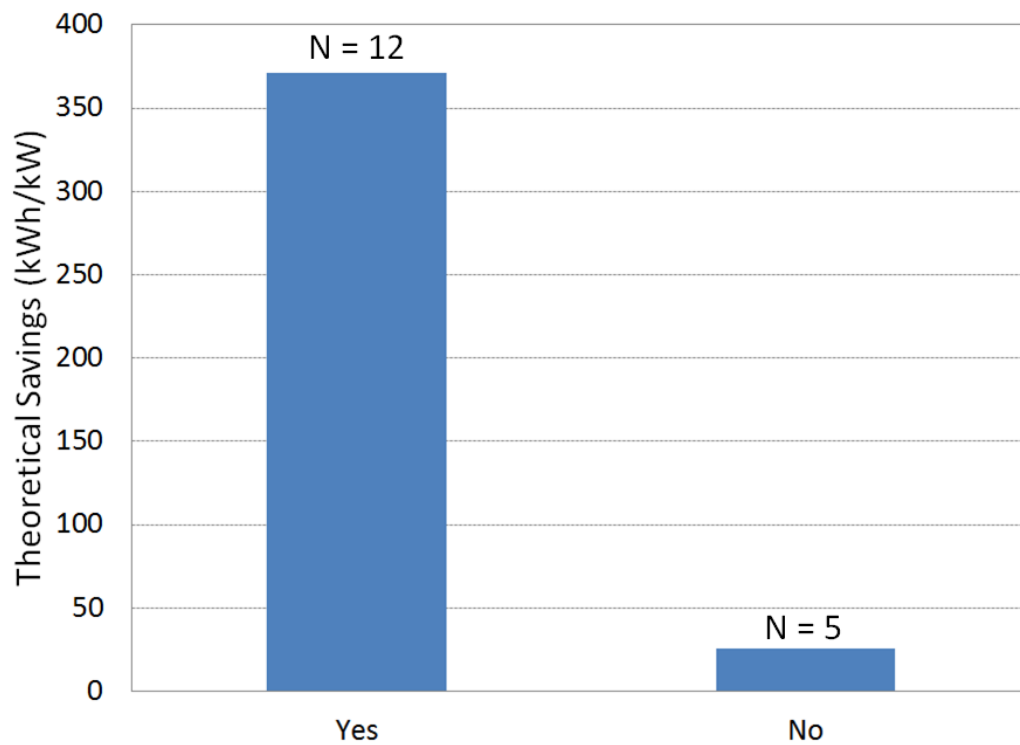

Significant energy savings potential from task tuning tends to correlate with systems that have photocontrol despite the photocontrol's diminishing of total achievable savings⁴ (see section Energy savings interactivity for more detail). However, this correlation is likely more indicative of the type of spaces served rather than the photocontrols. For example, the systems with photocontrol tended to be larger spaces with longer hours of operation. The systems without photocontrol were predominantly conference rooms, which were tunable due to their A/V needs, but had relatively few hours of operation. As LEDs gain marketshare in the former application, this strong correlation is likely to diminish.

Occupant Comfort

From our occupant surveys, we know the occupants' general level of satisfaction with respect to the amount of light in their space. Figure 33 illustrates the relationship between this level of satisfaction before tuning and the space's percentage reduction. The scale of satisfaction ranges from 1 (very satisfied) to 7 (very dissatisfied).

⁴ Photocontrols regulate the use of electric lights based on the amount of daylight available. When daylight displaces the need for electric lighting, it reduces the potential savings from task tuning.

Figure 33: Level of satisfaction with light level versus percentage reduction.

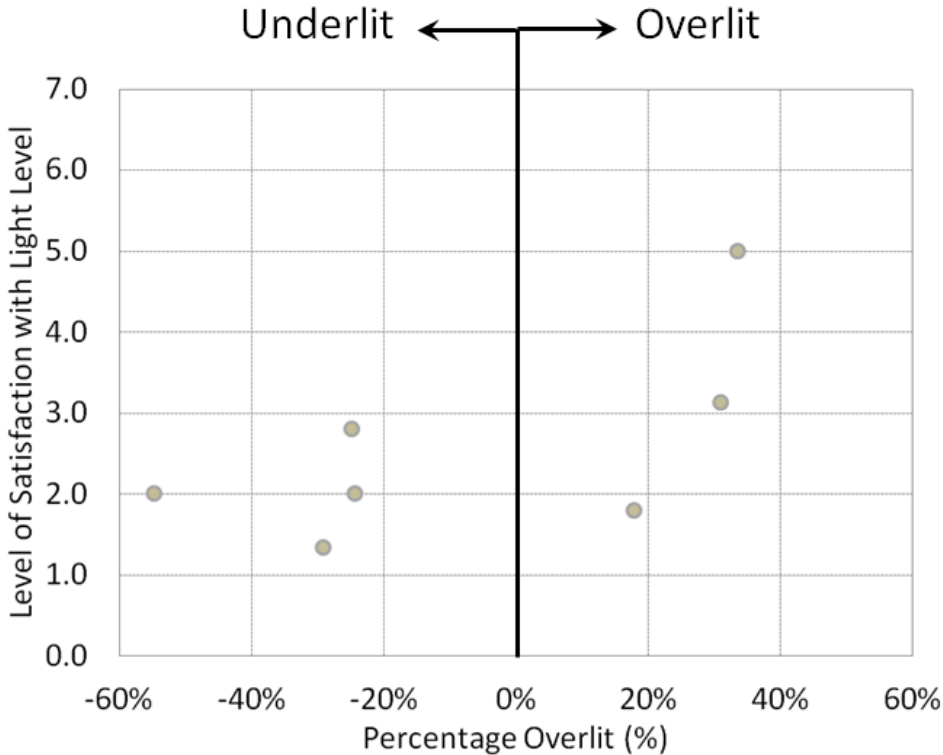

We included only those spaces for which we received completed occupant surveys. Counterintuitively, the spaces that were over lit had lower levels of occupant satisfaction than those that were under lit. This is possibly due to the under lit spaces having been designed by a lighting designer, meaning that the low light levels are enhanced by other controls and functionality. Unfortunately, we did not receive sufficient post-tuning occupant surveys to draw conclusions about the impact of tuning on occupant satisfaction. However, we have yet to receive a single occupant complaint regarding our tuned light levels. We believe this is due to our approach of incorporating occupant feedback into the tuning process itself.

Energy Savings Interactivity Results

Another potential use for the set of theoretical calculations is to understand the interactivity between photocontrol and task tuning savings. In the Theoretical Energy Savings and Energy Savings Interactivity sections, we outlined the methods for calculating task tuning savings in systems with photocontrol and for the same systems had they not had photocontrol.

Table 10 compares these savings based on tuning to recommended light levels, with median values for the over lit spaces in the study highlighted at the bottom. The systems that did not have photocontrol are not included in this analysis.

Table 10: Energy savings (in kWh/kW) from task tuning a system with photocontrol and the same system had it not had photocontrol.

| ID | Space Description | Savings (kWh/kW) | | |
|---------------------------------------|-------------------|------------------------|----------------------|-------|
| | | With Photocontrol | Without Photocontrol | |
| Over lit | O Off 2 | Open Office | 2910 | 4719 |
| | Study | Study Area | 1558 | 1727 |
| | Stack | Library Stacks | 1380 | 2477 |
| | Comp 2 | Computer Lab | 1148 | 1148 |
| | Comp 1 | Computer Lab | 833 | 833 |
| | Class | Classroom | 312 | 312 |
| | Trans | Transportation Waiting | 121 | 122 |
| Under lit | O Off 1 | Open Office | -233 | -315 |
| | P Off | Private Office | -420 | -1663 |
| | O Off 4 | Open Office | -526 | -575 |
| | Comp 3 | Computer Lab | -1243 | -1904 |
| | O Off 3 | Open Office | -1390 | -1565 |
| Summary Statistics⁵ | | | | |
| Average | | 1180 | 1620 | |
| Median | | 1148 | 1148 | |
| Minimum | | 121 | 122 | |
| Maximum | | 2910 | 4719 | |

In the system with the most savings, photocontrol reduced the maximum savings dramatically from 4,719 to 2,910 kWh/kW, or 38 percent. This indicates a strong interaction between task tuning savings and photocontrol in some spaces. Figure 34 displays this interaction graphically.

⁵ The summary statistics are for the seven over lit spaces only. The theoretical estimates show that the average savings from task tuning with photocontrol are approximately 1180 kWh for every kW of lighting that is dimmable. If the same systems had not had photocontrol the savings from tuning would be approximately 1620 kWh/kW. Therefore, on average, photocontrol diminishes the savings from task tuning by 440 kWh/kW or 27 percent. However, it should be noted that task tuning savings of systems with photocontrol remains relatively high, albeit lower than systems without photocontrol. Note that this reduction should not be applied to the measured savings estimates stated in this report, as the majority of those systems already had photocontrol.

Figure 34: Energy savings (in kWh/kW) from task tuning a system with photocontrol and the same system had it not had photocontrol.

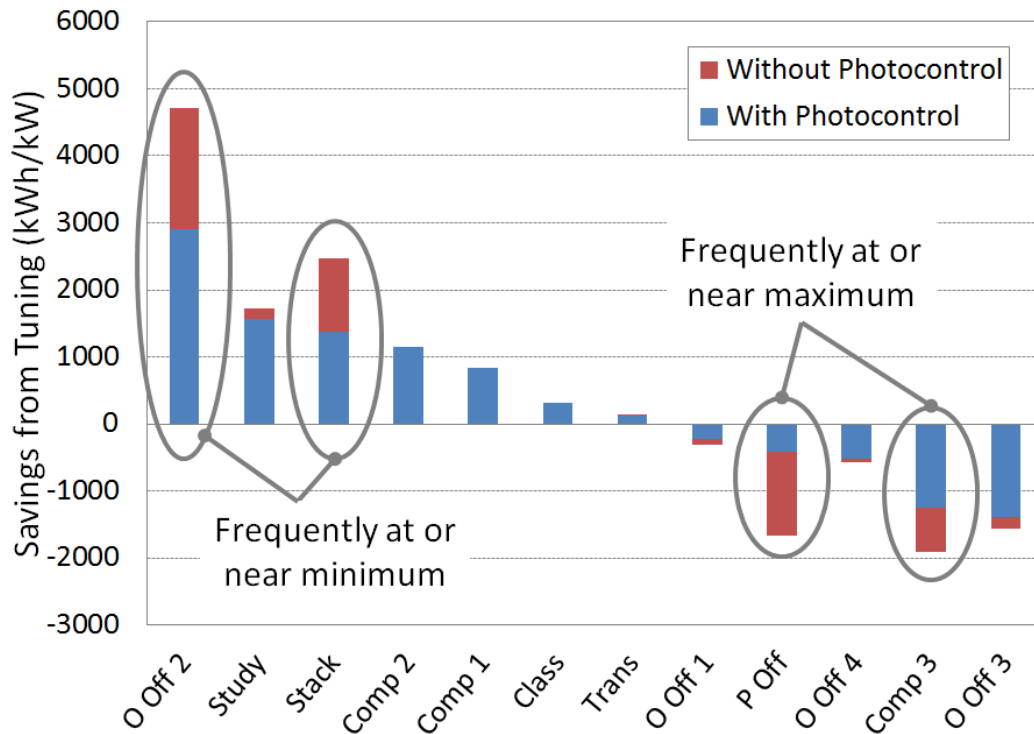

In the majority of spaces (8), photocontrol had little to no interaction with the savings from task tuning. However, in the remaining spaces (4) it accounted for nearly 45 percent reduction in savings. These spaces are the ones for which the photocontrols dimmed the lights to or near their minimum power for large portions of the time. Conversely, for the under lit spaces, these spaces were the ones for which the photocontrols did not dim the lights from their maximum power for large portions of the time.

Correlation between Energy Savings and Percent Reduction

The final potential use for the set of theoretical calculations is to evaluate the validity of estimating energy savings based solely on the percentage by which the lighting in a space was reduced. A correlation of this nature would allow CIP staff to quickly estimate energy savings for a given system, with simple light level measurements.

The coefficient of determination of this correlation is sufficiently low so is not considered a valid correlation. The percentage reduction should therefore not be used as an approximation of the energy savings from task tuning, particularly for spaces with photosensors. It is still true, however, that percentage reduction is a reasonable guide to whether a space is worth tuning.

Figure 35 illustrates the theoretical percent savings as a function of the percent that a system is over lit for all the over lit spaces in our study.

The coefficient of determination of this correlation is sufficiently low so is not considered a valid correlation. The percentage reduction should therefore not be used as an approximation of the

energy savings from task tuning, particularly for spaces with photosensors. It is still true, however, that percentage reduction is a reasonable guide to whether a space is worth tuning.

Figure 35 Theoretical energy savings (by %) versus percent reduction.

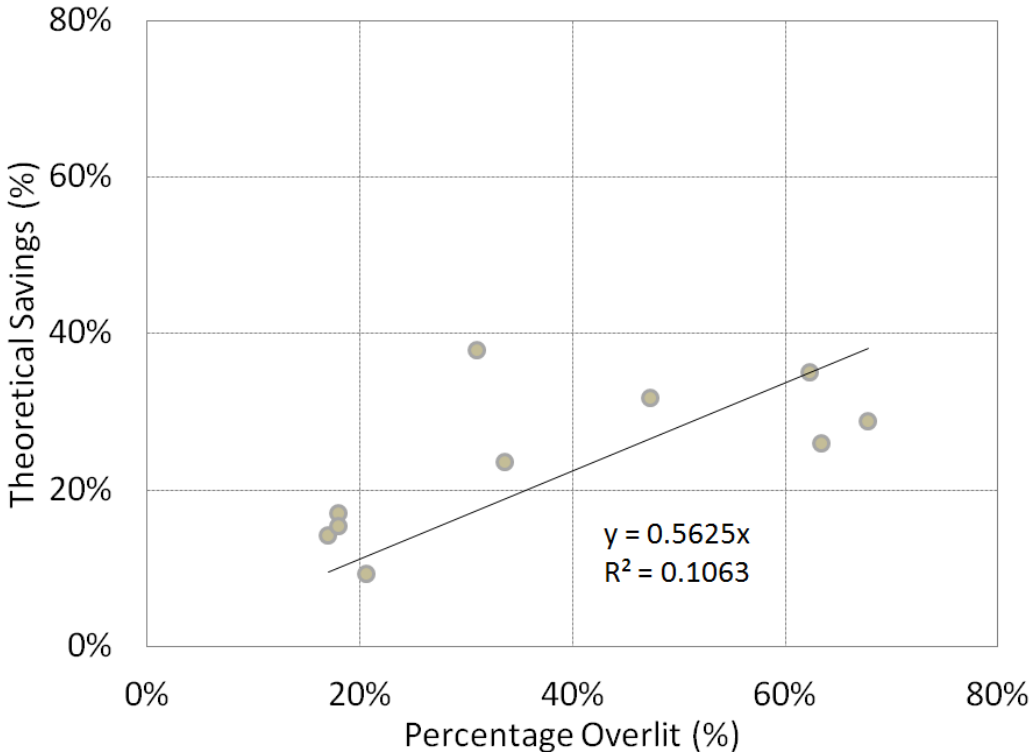

Economics of Task Tuning

In order to understand the economics underlying task tuning, we performed both a life cycle cost and a simple payback analysis.

The incremental cost of task tuning includes the additional equipment required to dim the lights and the time associated with actually tuning the system. The equipment needed to convert a non-dimming system into a dimming system includes dimming ballasts, controllers, and sensors. Dimming systems can range in complexity and cost. The simplest of dimming systems, such as standalone controls integral to the luminaire (or fixture), are not likely flexible enough to fully accomplish task tuning as they can typically adjust the photosensor setpoint (daytime) but not the high end trim (nighttime). A fully automated system which incorporates digitally addressable ballasts with multiple levels of programming functionality and remote interface is more complex and costly than necessary to task tune a space. Therefore, when developing the equipment costs, we analyzed a system between these two extremes: one with a programmable module or head end equipment with simpler inputs but the functionality to change both the photosensor setpoint and high end trim.

The time associated with task tuning involves becoming familiar with the lighting control system, measuring average light levels, and adjusting the lighting system to provide

recommended light levels. The time requirement varies considerably based on the tuner’s level of familiarity with the lighting system. For example, it would take someone who is very familiar with the system (i.e. a lighting manufacturer representative or commissioning agent of a new system) much less time than someone who is not familiar with the system (i.e. an energy service representative trying to tune an existing system).

Although calculating non-energy savings was not part of the scope of our analysis, task tuning can contribute to them. Dimming of fluorescent ballasts results in a decrease of the ballast case temperature. There is a strong correlation between the lifetime of a ballast and the ballast case operating temperature. A reduction in light levels of 20 percent can potentially yield a significant enough temperature decrease to double the lifetime of the ballast, often the first fixture component to fail outside of the lamps themselves. In addition, the switching frequency of the lamps decreases with dimming controls contributing to increased lamp life.

Life Cycle Cost Analysis

It is not obvious on most projects whether the first cost increase of a given technology is justifiable based on energy savings. We have therefore completed a life cycle assessment based on the benefit of the energy cost reduction. This analysis does not include additional benefits such as incentives, increased productivity, carbon credits, or the increased lifetime outlined previously. This assessment is valid for building design teams or owners looking to incorporate task tuning, and also for utility program personnel in Minnesota who need this type of information to implement and evaluate a task tuning program.

We conducted life cycle cost analysis in accordance with the procedures in the Federal Energy Management Program (FEMP) (NIST 1995). The inputs to this analysis are shown in Table 11. Note that we are not addressing maintenance cost here, as we have observed that most systems do not require additional maintenance of the dimming controls.

Table 11. Economic inputs for life cycle cost analysis.

| | Value | Basis |
|-----------------------------|---------------|---|
| Electricity cost | \$0.097 / kWh | Average commercial electric rate in MN, according to EIA |
| General inflation | 2.2% | Difference between 20 year treasury bills, inflation adjusted and not |
| Fuel inflation, electricity | 2.8% | FEMP 10 year outlook |
| Total tax rate | 45% | Nominal federal business tax rate + MN corporate tax rate |
| Depreciation of equipment | 13.9 years | Straightline depreciation |
| Discount rate | 5-9% | 9% for the corporation scenario, 5% for an institutional scenario |
| Life cycle cost timespan | 13.9 years | Lifespan of dimming ballast; FEMP |

We divided building owners into two primary economic categories: corporation and institution. We considered the economic outcome of these owners choosing dimming controls in Minnesota as differing in two significant ways. Corporations are assumed to use a higher discount factor of nine percent, and pay corporate tax rates typical of Minnesota businesses. Institutions are assumed to pay no taxes, and use a lower discount factor of five percent. Following FEMP guidelines to decide whether to adopt a technology, these organizations would need to determine whether the net present value of the technology was positive or negative. Because the costs of these systems can vary so much depending on the complexity of the control system and the time associated with implementing task tuning, it is most useful to determine the cost at which the owner would break even (have a net present value of zero). For our average value of energy savings, this results in the break-even costs shown in Table 12 for a 1 kW system.

Table 12. Break-even costs for task tuning of 1 kW of lighting.

| | Typical Dimming System |
|---------------------------------|-------------------------------|
| Average energy savings (kWh/kW) | 613 |
| Break-even cost, institution | \$713 |
| Break-even cost, corporation | \$771 |

For a typical system, both an institution and corporation can afford to spend about \$750 per kilowatt of dimmable lighting for hardware and time associated with task tuning. This equates to about \$0.75 per square foot for a building with a lighting power density of 1.0 watt per square foot.

Simple Payback Analysis

Though we would recommend using the technical and thorough economic metrics of the previous section to judge the merit of task tuning, some readers will still be interested in payback metrics.

For this analysis, we needed to develop typical costs for task tuning. We therefore assumed that the lighting system (or similar lighting systems) served 25,000 square feet of dimmable lighting with an average lighting power density of 1.0 watt per square foot. These assumptions are in line with the buildings and systems in our study.

When estimating the incremental equipment costs for a continuous dimming system, we assumed a stepped dimming system as our baseline. We made this assumption because the majority of the spaces in our study had photocontrol. In addition, the new building energy code in Minnesota, ASHRAE 90.1-2010, requires stepped dimming in most side lit spaces. Switching from stepped to continuous dimming ballasts was assumed to cost an additional \$50 per ballast for a 2-lamp T8 ballast with a normal ballast factor. The control system was assumed to upgrade from standalone controls integral to the fixture to a lighting control system with programmable head end equipment requiring simple inputs. This upgrade was estimated to cost approximately \$0.75 per square foot. We estimated that in order to tune the lights in this scenario, it would take an experienced technician or contractor approximately 10 hours, at a

labor cost of \$80 per hour. Note that all of these costs scale with square footage, and that our assumed 25,000 square feet serves both as an example and as a minimum below which the embedded fixed costs become disproportionately large.

Using these assumptions, we calculated an incremental cost for upgrading to a continuous dimmable lighting system and then implementing task tuning of \$1.66 per square foot, resulting in a simple payback of 28 years. It is evident therefore that task tuning alone is unlikely to economically justify the cost of upgrading to a dimming system. This upgrade is more likely to be driven by other design requirements such as daylighting, controllability needs (such as in a space with A/V), or occupant satisfaction (eliminate the distraction of on/off switching). We therefore analyzed the payback from task tuning for a dimmable system without the equipment costs.

This situation is likely in two cases: a new system and an existing system. In both cases, we now assume that the equipment (ballasts, controls, and sensors) have already been decided upon and are not included in the incremental cost. In both situations, the only incremental cost is the time associated with tuning. The new system case may be associated with either a new construction or major renovation project. For this case, we assume that the experienced technician or contractor would take about the same amount of time as before (10 hours), since they would already be familiar with the system since they participated in the design and commissioning process. For the existing system case, more time would be required to understand the system, learn how to adjust its controls, as well as understand the zoning of light fixtures. We therefore assumed that the same experienced technician or contractor would need twice the time to tune the existing system (20 hours). For these cases, we calculate a cost of between \$0.03 and \$0.06 per square foot, resulting in a reduced simple payback of between 0.5 and 1.1 years for the new and existing system cases, respectively. **Due to these short payback periods, we recommend that task tuning be implemented in new construction projects or major renovations in which a dimming system is already planned as part of the design requirements. For the same reason, if a dimming system already exists in a facility, task tuning should be strongly considered as a way to achieve cost-effective energy savings.**

Although task tuning does not stand alone as a reason to purchase a dimming system, task tuning would help justify the installation of a more complex lighting control system than originally planned, or stop a dimming system that is part of a lighting design from being cut due to budget constraints.

Minnesota Savings Potential

Following the assumptions outlined in the Extrapolation Methodology section, the final estimated annual savings potential from task tuning incentive programs in Minnesota are shown in Table 13.

Table 13. Potential savings from task tuning in Minnesota.

| Building Type | Building elec. consumption from area lighting (%) | Tunable lighting electricity consumption (GWh) | Estimated electricity savings (MWh) | Annual dollar savings (\$) | Avoided GHG emissions (tCO2 eq.) |
|--------------------------|--|---|--|-----------------------------------|---|
| Education | 30% | 215.3 | 710.5 | \$68,917 | 685 |
| Office | 48% | 826.8 | 2728.3 | \$264,643 | 2630 |
| Public Assembly | 23% | 153.1 | 505.2 | \$49,002 | 487 |
| Warehouse/Storage | 38% | 327.3 | 1079.9 | \$104,754 | 1041 |
| Total | n/a | 1522.4 | 5023.9 | \$487,316 | 4843 |

In total, we estimate that task tuning could potentially save Minnesota 5,023 megawatthours annually, or the equivalent of 528 typical Minnesota household’s annual electric consumption.⁶ This energy savings would reduce greenhouse gas emissions by 4,843 tons of carbon dioxide, or the equivalent of taking 1,020 passenger vehicles off the road for a year.⁷ This energy savings equates to over \$487,000 of annual cost savings.

CIP Recommendations

Lighting in commercial buildings has been the target of energy efficiency programs for many years. Historically, reductions in lighting energy consumption have been achieved by implementing new technology with improved luminaire efficiency, such as replacing T12 fluorescent lamps with T8 or T5 lamps or upgrading fluorescent fixtures to LEDs.

However, recent changes to U.S. DOE’s energy conservation standard for general service fluorescent lamps, more stringent state and local building codes and changes to ASHRAE Standard 90.1, have begun to change the baseline of installed lighting efficiency and are eroding the cost-effectiveness of providing incentives for T12 replacements (the work horse for most lighting efficiency programs). Additionally, as LED lighting gains market share, its inherently dimmable quality adds to the opportunities for lighting controls that were not possible with non-dimmable systems. Given these market changes, energy efficiency program administrators must now consider implementing programs that go beyond efficacy-based, per product incentives (Aki 2014).

A few lighting efficiency programs have begun to crop up that are designed to reduce lighting energy consumption through the use of advanced lighting controls. These programs generally provide a performance-based incentive and/or an incentive for an advanced control system that, minimally, employs the following strategies:

- Task tuning

⁶ Annual electricity consumption of typical Minnesota household of 9,519 kWh/yr. (EIA g 2012)

⁷ Annual greenhouse gas emissions from passenger vehicles of 4.75 tCO2. (EPA 2011)

- Scheduling
- Daylight harvesting/photo sensing
- Occupancy sensing
- Variable load shedding (demand response)

A few examples of these programs are shown in Table 14.

Table 14. Examples of Advanced Lighting Controls Programs

| Program | Incentive | Project requirements |
|--|---|---|
| <p>Efficiency Vermont RELIGHT</p> <p>Rebate and incentive to offset the cost of hiring a professional lighting designer.</p> | \$500 plus \$0.03 per sq. ft. | Qualified lighting designers |
| <p>Focus on Energy SMART Lighting</p> <p>Performance incentives offset the cost of hiring a professional lighting designer.</p> | \$0.04 per kWh and \$125 per kW saved plus \$0.02 per kWh for performing acceptance testing | Qualified lighting designers |
| <p>MassSave Networked Lighting Controls</p> <p>Promotes the installation and commissioning of lighting control systems both for new construction and retrofit projects.</p> | \$0.50 per sq. ft. (up to a maximum of \$200,000 not to exceed 75% of incremental cost in new construction or 50% in retrofit) | <p>Large buildings > 25,000 sq. ft.; > 150 lighting fixtures</p> <p>Must achieve 40% energy savings below baseline kWh use</p> <p>Qualified products</p> |
| <p>SMUD Advanced Lighting Controls</p> <p>Encourage medium to large size commercial customers to adopt advanced lighting controls.</p> | \$0.25 per kWh saved (up to a maximum of \$100,000 or 70% of the total project cost) | <p>SMUD approved</p> <p>Qualified products</p> <p>Existing systems must be dimmable (bi-level or step dimming not acceptable)</p> |
| <p>ComEd Smart Ideas Advanced Lighting</p> <p>Offers incentives for installation of new intelligent lighting control system when coupled with installed lighting power reduction and 30-day post measurement and verification</p> | \$0.50 per Watt reduced plus \$0.18 per controlled Watt where installed lighting and controls exceed baseline plus \$1,000 for use of National Advanced Lighting Controls Training Program certified contractor; \$0.10/kWh additional incentive available for measured kWh savings exceeding target values | <p>Qualified fixture (T8/T5 fluorescent and LED only) and control system products</p> <p>Baseline lighting design compliant with IESNA recommendations or local code requirements</p> |

Both the MassSave and SMUD programs also require customer and/or facility manager training in using the system.

Program Approaches

There is growing potential in Minnesota to capture energy savings from lighting control strategies. LEDs are gaining market share for a range of interior applications and changes to the building code in Minnesota will help drive the market for dimmable lighting systems. Even when dimmable lighting systems are installed, tuning the system is not standard practice and many spaces are over lit as a result.

We suggest three approaches to take advantage of the potential savings from advanced lighting controls: ranging from a simpler, lower cost prescriptive program to a more complex, higher cost program. We also recommend establishing the incentive on a per square foot basis for the following reasons:

- It is a number that building owners understand and are used to using in the decisions they make regarding their building
- It more clearly shows the degree to which the incentive offsets incremental costs
- It can be readily incorporated into project budgeting
- It sends a consistent, upfront signal in contrast to performance incentives which can't be determined until there is a completed project scope and some initial engineering calculations

Table 15. Program Approaches for Advanced Lighting Controls

| Program | Description | Incentive | Delivery |
|--------------------|---|---------------|--|
| Prescriptive | Tier 1: install dimmable lighting power and associated controls | per sq. ft. | Use qualified contractors |
| | Tier 2: tune dimmable lighting | per sq. ft. | |
| Retrocommissioning | Tune existing dimmable systems | per kWh saved | Use qualified energy service representative or controls representative |
| Enhanced Lighting | Comprehensive approach from design through commissioning | per sq. ft. | Use qualified lighting designers/contractors |

The prescriptive program approach allows flexibility for building owners who might be considering a lighting system retrofit. The program provides an incentive for them to install dimmable lighting systems and associated controls. We then suggest offering a larger incentive for actually tuning the system rather than for only installing it. This encourages building owners to take advantage of the additional savings possible from these systems. The tuning itself should be performed by a qualified contractor, lighting controls manufacturer or trade ally who has participated in a utility program approved training on lighting controls. More information on appropriate level of training is outlined subsequently.

A retrocommissioning program is a more comprehensive approach and would target buildings that already have dimmable lighting systems. It could include adjusting scheduling, photo sensors and occupancy sensors as well as tuning. The tuning itself should be conducted by a trained Energy Service Representative. Alternately, an approved individual, similar to the Prescriptive program, could conduct the tuning.

The enhanced lighting program would target new construction or major retrofits and offer a comprehensive approach that would include professional lighting design and commissioning.

When dimming already exists in a building, the program could stand alone as task tuning specific. Alternately, when dimming does not already exist, the tuning could be layered onto an existing program, such as a lighting retrofit program. This would be a good situation to offer an additional incentive for tuning.

Outreach

The outreach goal for a task tuning program would be to find buildings with dimmable lights. In general, this entails buildings with daylighting controls (i.e. plenty of perimeter zones) or LEDs. Typical buildings types include:

- Office: Ideally, the project would include large open offices with high controlled power or many private offices in which you can apply the same tuning approach quickly by copying control settings.
- Education: Ideally, the project would include many similar classrooms in which you can apply the same tuning approach quickly by copying control settings.
- Institutional: Libraries and higher education facilities are great candidates, allowing program personnel to train a small number of facility staff who could then apply tuning to a number of buildings.
- Big Box Retail: Combining high lighting powers with increasing penetration of highbay LEDs means that there is significant potential for task tuning energy savings. However, programs will face obstacles in convincing owners to reduce light levels, as they often view this as potentially reducing product sales. However, there is a trend in retail lighting design towards lower ambient lighting paired with the use of more accent lighting to highlight the merchandise. As this trend continues, there is likely increasing potential for task tuning in retail applications.
- Light Manufacturing: Similar to big box retail, this sector has high lighting powers and increasing penetration of highbay LEDs. However, safety concerns around potentially dangerous manufacturing process may be an obstacle. Coupling task tuning with task lighting may be a way around this.
- Warehouse: New code requirements for skylights and associated daylight sensors coupled with higher penetrations of highbay LEDs will lead to increasing potential in this sector. Large areas of similarly controlled lights and low demand for light level targets help with cost effectiveness.

- Parking Garages: New code requirements for lighting controls in parking garages will lead to increasing potential in this sector. Large areas of similarly controlled lights and low demand for light level targets help with cost effectiveness.

The Energy Savings Relationships section further indicates that buildings with lighting designed by a contractor and little to no commissioning are good candidates as well. Programs should partner with a variety of organizations to find potential projects:

- Multiple building owners: property management companies, higher education, government (state, county, city), retail chains
- Professions: electrical contractors, lighting controls manufacturers, design firms
- Professional Organizations: IES, IFMA, USGBC, ASHRAE

Analysis and Training

Determining the energy savings associated with task tuning is outlined in the Methodology and Analysis section of this report. We have developed a checklist that could be followed by program staff when undertaking task tuning of a given lighting system. This checklist may be found in Appendix B: Task Tuning Checklist.

In order to successfully implement task tuning, program staff or trade allies should be trained and proficient in a variety of lighting-related subjects.

1. **Fundamentals of Lighting:** This course was developed by the Illumination Engineering Society and covers a range of lighting-specific subjects at an appropriate level for gaining proficiency in task tuning. The class is offered through local chapters of IES, such as the Minneapolis St. Paul chapter⁸ and participants typically meet one night per week for two and a half hours. Relevant topics include:
 - a. Basic Lighting Concepts, Vision, and Color
 - b. Electric Light Sources and Ballasts
 - c. Luminaires and Lighting Controls
 - d. Photometry and Lighting Calculations
 - e. Lighting for Interiors
2. **Lighting Controls:** The Lighting Controls Association's Education Express⁹ offers a variety of lighting control and dimming control classes.
3. **How to use a light meter:** The documentation that accompanies a specific light meter will provide the majority of the detail needed to operate the light meter. However, proper placement of the light meter is necessary in order to get the most accurate readings. Light meters should be placed on the working surface when possible, and the person operating the meter should ensure that they are not blocking any light by

⁸ [Minneapolis-St. Paul Chapter of the Illuminating Engineering Society web site](http://iesmsp.org/), (<http://iesmsp.org/>)

⁹ [Lighting Controls Association Education Express web site](http://aboutlightingcontrols.org/Education_Express/welcome.php), (http://aboutlightingcontrols.org/Education_Express/welcome.php)

stepping away from the meter during the reading. When taking readings while holding the meter, the light meter should be held away from the body as far as possible, and the person should endeavor to position themselves in such a way as to block as little of the light as possible.

4. *Basics of major manufacturer control systems:* The biggest variable in any task tuning effort is understanding the nuances of the lighting control systems serving a given space. Efficiency program staff should work with control system manufacturers to develop training on the basics of their systems.

Verification and Persistence

There are several forms that a verification effort could take based on the program's needs. They may be grouped into two categories.

- Level 1: The first level of verification involves a high level check that task tuning has been undertaken. This could entail a program representative measuring light levels in a representative sample of incentivized buildings or checking that lighting controls have indeed been adjusted from their factory defaults. This level is less time consuming and less costly, but does not confirm actual energy savings.
- Level 2: The second level involves an effort similar to the Measurement and Verification process outlined in the International Performance Measurement and Verification Protocol (DOE 2002) or ASHRAE Guideline 14 (ASHRAE 2012). This typically entails using power meters or current transducers to measure lighting system energy consumption both before and after the task tuning has occurred. The associated energy savings is then determined by comparing the normalized energy consumption from both periods. This level is more time consuming and costly, but does confirm actual energy savings.

As with any efficiency program, energy savings persistence should be considered. Typically, savings from lighting control measures have a useful life of seven years. However, since there is a strong occupant comfort component to task tuning, the risk of shorter savings periods exists. This risk may be mitigated by involving the building occupants and facility staff in the task tuning process. Getting their feedback as to appropriate light levels is helpful in maximizing energy savings while maintaining a high level of occupant comfort. Further, educating only one point of contact, typically the facility manager, on how to use their lighting controls, and why task tuning is important helps with savings longevity.

An alternate approach to tuning that may result in a higher level of persistence is to task tune during unoccupied periods. This approach is in contrast to the previously outlined approach, in that it does not include occupant feedback. The intent of this approach is to make smaller incremental reductions in light levels that occupants will not notice, as they do not occur when the occupants are present. Care should be taken in this approach that the tuned light levels are conservatively high, to mitigate the possibility of visual discomfort.

Cost Effectiveness

The most cost effective task tuning programs would focus on buildings with large areas of similarly controlled lighting, such as large open offices or a number of classrooms for which the same level of tuning could quickly be applied. Regardless of the building, it is likely not cost effective to measure the light levels in all spaces. Rather, a sample of representative spaces should be identified and measured. The resulting lighting level reduction should then be applied to all similar spaces. Additionally, PC based systems can be tuned quickly, even allowing tuning to occur remotely with a couple key strokes after measurement occurs. Stand-alone systems are more time consuming as the tuning has to occur on-site by going from system to system. Finally, higher program cost effectiveness is achieved when coupled with a lighting retrofit, since there is a high fixed cost in merely getting into the building, understanding the spaces, and associated lighting controls. Once this is done, the time associated with actually tuning the lights is relatively small. The tasks and associated time for task tuning a system are outlined below. These estimates do not include the outreach time associated with getting a building to apply to the program.

1. **Preparation (2-4 hours):** This task includes acquiring and reviewing building drawings, specifications, and lighting control documentation. In addition, time must be spent coordinating the site visit.
2. **Measurement (2-4 hours)**
 - Site tour
 - Facility staff and occupant interviews: Any issues? Targets?
 - Measure pre-tuned light levels
 - Calculate pre-tuned average and critical light level
 - Determine recommended average light level
 - Calculate recommended critical light level
3. **Controls adjustment (2 hours)**
 - Determine sequence for adjusting light levels
 - Adjust system to recommended working plane light level
 - Verify that critical light level meets recommendation

Best Practices and Lessons Learned

While the concept of task tuning is relatively simple – use the dimming capabilities and controls of the lighting system to reduce light levels to appropriate levels – there are a number of conditions that prevent it from being a cookie cutter solution to reducing lighting energy use. As we implemented task tuning in the spaces we studied, we compiled a list of the situations we encountered and lessons learned.

Task tuning is essentially a tradeoff between energy consumption of a lighting system and light levels in a space. When performing task tuning, it is important to balance energy savings with occupant visual comfort, as aggressive tuning will result in high energy savings at the expense of occupant satisfaction.

Complicating this balance is the fact that occupants perceive light levels differently both between individuals and under varying situations. For instance, when tuning a lighting system different occupants may simultaneously provide feedback that the tuned light levels are both too low and just right. Additionally, if an occupant is present when the tuning occurs, they may provide immediate feedback that the tuned light levels are too low, simply because their eyes were adjusted to the previous, higher light levels. Had the tuning occurred without them present, the lower light levels may have gone unnoticed when the occupant first perceived them upon arrival into the space.

Because of these complexities, there are two general approaches to task tuning with respect to occupants:

Tune during Unoccupied Periods: This approach involves tuning lighting systems with no occupant feedback.

- Strengths
 - Without occupant feedback, the tuner can adjust the lights to a level that maximizes energy savings.
 - Minimizes the chance of an occupant providing false feedback based on perceived relatively lower light levels
 - If tuned at night, the tuning process itself is less complicated as outlined in Appendix B: Task Tuning Checklist.
 - Reduced complexity means tuning takes less time and is less costly
- Weaknesses
 - Increases risk of occupant visual discomfort and associated complaints
 - Increases risk of lower rates of savings persistence, as facility managers respond to occupant complaints

Tune during Occupied Periods: This approach involves tuning lighting systems with occupant feedback, either through formal pre/post surveys or informal conversations during tuning.

- Strengths
 - Decreased risk of occupant discomfort and associated complaints
 - Increases savings persistence, as facility managers will not need to respond to occupant complaints
- Weaknesses
 - Occupant feedback may result in reduced or no energy savings. However, as in several of the spaces that we tuned, getting occupant feedback may actually result in increased energy savings, as occupants may be comfortable with light levels below IESNA recommendations.
 - Potential exists of an occupant providing false feedback based on perceived relatively lower light levels
 - If tuned during the day, the tuning process itself is more complicated as outlined in Appendix B: Task Tuning Checklist.
 - Increased complexity means tuning takes more time and is more costly

We recommend that task tuning be conducted with occupant feedback, due to the approach's balance of energy savings and occupant visual comfort. However, if including occupant feedback is too complex or costly, special care should be taken to not adversely affect occupant visual comfort. One method to ensure this would be to choose conservative light level reductions. For instance, if a space was found to have an average illuminance of 60 fc, but IESNA recommendations were 30 fc, a conservative reduction would be to reduce the average illuminance to 45 fc. Although this would result in lower immediate energy savings, it would increase energy savings persistence, as facility managers would be less likely to override tuned controls based on occupant complaints.

Another approach would be to lower light levels incrementally during unoccupied periods over the course of several weeks. For instance, if a space was to be tuned from 60 to 30 fc, a facility manager or other onsite personnel could reduce the light levels at night in 5 fc increments over the course of six weeks. In this way, the occupants would acclimate to each new light level, as opposed to having to adjust to the entire reduction at once. If an occupant does complain, the facility manager could simply raise the light levels to the previous increment before the complaint occurred. In this way, occupants could be indirectly polled without survey bias.

For both methods, there is also the risk that, even though the average tuned illuminance levels meet IESNA recommendations, a few areas or occupants are still not receiving enough light to perform their tasks. This is particularly prevalent in spaces with widely spaced lighting or tall cubicles or partitions. This situation can be avoided by checking that the illuminance at the critical workplane is not too low. The critical workplane is defined as the location where an occupant is performing a task that has the lowest light level. Polling the occupant at this location directly is the surest means of determining whether they are comfortable with the lower light levels. If the light levels are too low, the ambient light level may simply be increased, or task lighting may be added at this location. As discussed previously, requesting occupant feedback may be too complicated or not timely. A method for determining suitable critical workplane illuminance without occupant feedback involves the following. Note that this method deviates from the method we outline in Appendix B: Task Tuning Checklist, by tuning based on critical illuminance and not average illuminance:

1. Based on IESNA recommendations, determine the tuned average illuminance for the space
2. The ratio between the average and critical illuminance is defined as:

$$U_{ave/min} = \frac{\textit{Tuned Average Illuminance}}{\textit{Tuned Critical Illuminance}}$$

The IESNA Lighting Handbook recommends that this ratio be below 1.5 (DiLaura 2011). For example, a space with an average illuminance of 30 fc should not have any workplane illuminance below 20 fc.

3. Given the recommended ratio between average and critical illuminance, calculate a tuned critical illuminance for the space.

$$\textit{tuned critical illuminance} = \frac{\textit{tuned average illuminance}}{1.5}$$

4. Perform task tuning on the space, such that the illuminance measured at the critical workplane by a light meter is equivalent to the calculated tuned critical illuminance above.

Within this method, the space’s actual average illuminance is not required. In fact, for problematic spaces with high averaged-to-tuned illuminance ratios ($U_{ave/min} > 1.5$), the average illuminance after tuning will be much higher than that recommended by IESNA. However, the point of this approach is not to have the correct average illuminance, but rather to have a reasonable minimum illuminance.

As noted in Appendix B: Task Tuning Checklist, there are five types of spaces that could be tuned:

- A: Spaces without daylight
- B: Spaces with daylight, blinds and photosensor
- C: Spaces with daylight, blinds and no photosensor
- D: Spaces with daylight, no blinds and photosensor
- E: Spaces with daylight, no blinds and no photosensor

The differentiating features between each is whether the space has daylight present, whether you can reduce the amount of daylight by adjusting blinds, and whether the lights are controlled by a photosensor. Spaces without daylight are the simplest to tune since there is no daylight to contend with or photosensor controls to adjust. These spaces may be tuned at any time. Having blinds in spaces with daylight allows the person tuning the system to reduce the available daylight to below the recommended average illuminance. Without blinds, the available daylight can be significantly higher than the recommended average illuminance, resulting in an inability to check through light meter measurements that the photosensor setpoint and high end trim are properly adjusted. Additionally, if the amount of daylight is too high, then occupants will not be able to give their feedback as to whether or not the light levels after tuning are appropriate. Ideally, tuning in spaces without blinds should be done during periods of low daylight such as under cloudy sky conditions.

Table 16 outlines additional lessons learned throughout our project.

Table 16. Lessons learned from implementing task tuning

| Topic | Issue | Lesson |
|-------------------------------|---|---|
| Useful light and lumen output | Delivered light (illuminance) is a better metric for evaluating LEDs than lumen output since it discounts wasted light. LEDs waste less light than their conventional counterparts. | Evaluating LEDs primarily on the basis of lumen output can underestimate or distort its performance and suitability for a given application. Lighting designers may be inclined to over light spaces when specifying LEDs leading to greater opportunities for task tuning. |

| Topic | Issue | Lesson |
|---------------------------|--|---|
| Scenes | Lighting controls can be used to lower light levels to preset levels such as A/V mode in classrooms or conference rooms. These settings affect the amount of savings from task tuning. | Account for scene control in determining the amount of savings from task tuning. |
| Getting accurate readings | A number of conditions make it difficult to get accurate light level readings, e.g., spaces with a lot of daylight. | Never take readings in direct sunlight. Lower blinds or pick spots away from windows. Let lights warm up before taking measurements. Light output can change over several minutes. Use a light meter, current transducer, or power meter to know when a system has equilibrated. |
| Tuning daylight spaces | More complicated than tuning non-daylit spaces. | Be careful not to be too aggressive with tuning (i.e. reducing light levels below IESNA recommendations). While there is ample light during most occupied hours, the periods of dawn and dusk can be problematic. |
| Occupant satisfaction | While IESNA has established light levels for various tasks, individual's needs vary. Tuning all ambient lighting does not account for individual preference. | Add task lighting for individual control. This strategy allows for energy savings from task tuning, while satisfying the few individuals whose visual needs are not met by this strategy. See previous discussion for more detail. |
| Retrofit applications | There are growing opportunities to add dimming ballasts, and photosensor controls in retrofit applications. This will increase the potential for task tuning over time. | It is essential to properly pair ballasts and lamps – an incorrect pairing will lead to premature lamp failure. |
| Establishing light levels | How do you determine the appropriate light level? | The IESNA Lighting Handbook publishes exhaustive tables of appropriate light levels by space type and task. For new construction, design intent may also be used For existing buildings, similar spaces in the same building or another of the owner's facilities may also be used. |

| Topic | Issue | Lesson |
|------------------------|---|---|
| Value of commissioning | Commissioning can be an expensive and time consuming process – is it worth it? | Yes, it ensures that light levels are correct, and catches other problems such as poor placement of photosensors or other issues with daylighting controls. |
| Miscellaneous barriers | Perception that dimming ballasts are prohibitively expensive, need more maintenance and fail frequently. Disconnect between owner’s needs and lighting designers vision. Lighting control systems not intuitive and differ by brand – steep learning curve just to figure them out. | |

Future work

There is considerable room for continued research on task tuning. We recognized a few specific issues during the course of our study.

It would be beneficial to measure a broader data set of system performances. Other space types such as warehouses and retail spaces could be studied. Expanding the study to look at more LED lighting systems would also be of interest over the coming years, as they continue to gain market share. Although we touched on the interaction between task tuning and photocontrol, more work is needed to understand the saving interaction between all the different lighting controls including task tuning, photocontrol, personal tuning, scheduling, and occupancy/vacancy controls.

More information is also needed on implementation rates of this technology. Not only is the data in CBECS more than nine-years old, it is also not entirely clear. Are owners more willing to pay the cost of sophisticated, complex full building control systems? What is the percentage of market share for full dimming systems? Is penetration into the new construction market still increasing, and is there any substantial penetration into the basic retrofit (not major-renovation) market? The CBECS dataset to be released later this year will contain relevant information to this end.

A final area for future study was identified from discussions with owners and contractors, specifically the issue of controls complexity. While it was clear that certain things made controls manipulation easier, such as graphic interfaces, minimal control setpoints, simplified zoning and ballast assignments, there is definitely a need to investigate what controls solutions might be more approachable for typical owners, operators, and contractors. It seems that this problem needs to be solved before these systems can become the control strategy of choice in the mass market, and perform robustly across the market. At the same time, if systems can be made less complex, the commissioning steps that we have outlined will become much easier for owners to incorporate and full savings will become much easier to realize.

References

- Aki. 2014. *Transcending Product Efficacy in Commercial Lighting Program Design: Considerations in Promoting Systems Approaches to Capture Deeper Savings*. Published in the proceedings of the 2014 ACEEE Summer Study on Energy Efficiency in Buildings.
- Araji. 2012. *Paradigm in Sustainability and Environmental Design: Lighting Utilization Contributing to Surplus-Energy Office Buildings*. Published in *Leukos*, volume 9, number 1, July 2012.
- ASHRAE. 2014. *American Society of Heating, Refrigeration and Air Conditioning Engineers*. "Standard 105-2014, Standard Methods of Determining, Expressing and Comparing Building Energy Performance and Greenhouse Gas Emissions", Table J2-D, pg. 23.
- ASHRAE. 2012. *Performance Measurement Protocols for Commercial Buildings: Best Practices Guide*.
- Boyce. 2000. *Individual Lighting Control: Task Performance, Mood, and Illuminance*. Published in the *Journal of the Illuminating Engineering Society*, Winter 2000.
- Census 2013. "Population Estimates – National, State, and Puerto Rico Commonwealth Totals Datasets: Population, population change, and estimated components of population change: April 1, 2010 to July 1, 2013."
- DiLaura. 2011. *The Lighting Handbook*. Published by the Illuminating Engineering Society.
- DOE. 2002. [International Performance Measurement and Verification Protocol](http://www.nrel.gov/docs/fy02osti/31505.pdf).
<http://www.nrel.gov/docs/fy02osti/31505.pdf>
- EIA a. 2003. U.S. Energy Information Administration's Commercial Building Energy Consumption Survey, [Table E3A](http://www.eia.gov/consumption/commercial/data/archive/cbecs/cbecs2003/detailed_tables_2003/2003set19/2003html/e03a.html),
http://www.eia.gov/consumption/commercial/data/archive/cbecs/cbecs2003/detailed_tables_2003/2003set19/2003html/e03a.html
- EIA b. 2003. U.S. Energy Information Administration's Commercial Building Energy Consumption Survey, [2003 detailed tables](http://www.eia.gov/consumption/commercial/data/2003/index.cfm?view=consumption),
<http://www.eia.gov/consumption/commercial/data/2003/index.cfm?view=consumption>
- EIA c. 2003. U.S. Energy Information Administration, Commercial Buildings Energy Consumption Survey (2003). "[Table C18A](http://www.eia.gov/consumption/commercial/data/archive/cbecs/cbecs2003/detailed_tables_2003/2003set15/2003html/c18a.html). Electricity Consumption and Conditional Energy Intensity by Census Division for All Buildings, 2003: Part 2."
http://www.eia.gov/consumption/commercial/data/archive/cbecs/cbecs2003/detailed_tables_2003/2003set15/2003html/c18a.html
- EIA d. 2003. U.S. Energy Information Administration, Commercial Buildings Energy Consumption Survey (2003). "[Table A1](http://www.eia.gov/consumption/commercial/data/archive/cbecs/cbecs2003/detailed_tables_2003/2003set1/2003html/a1.html). Summary Table for All Buildings (Including Malls), 2003."
http://www.eia.gov/consumption/commercial/data/archive/cbecs/cbecs2003/detailed_tables_2003/2003set1/2003html/a1.html
- EIA e. 2003. U.S. Energy Information Administration, Commercial Buildings Energy Consumption Survey (2012). "[2012 CBECS Preliminary Results](http://www.eia.gov/consumption/commercial/reports/2012/preliminary/index.cfm)."
<http://www.eia.gov/consumption/commercial/reports/2012/preliminary/index.cfm>

EIA f. 2015. U.S. Energy Information Administration, *Electric Power Monthly*, [Table 5.6.B. Average Retail Price of Electricity to Ultimate Customers by End-Use Sector](#).

http://www.eia.gov/electricity/monthly/epm_table_grapher.cfm?t=epmt_5_06_b

EIA g. 2012. U.S. Energy Information Administration (2012). "[Average monthly residential electricity consumption, prices, and bills by state](#)." <http://www.eia.gov/tools/faqs/faq.cfm?id=97&t=3>

EMCOR. 2012. *LED Office Lighting and Advanced Lighting Control System (ALCS)*. Prepared for Pacific Gas and Electric Company.

Encellium. *Lighting Control for the Smart Building, Case Study University Health Network Toronto General Hospital*. Prepared by Encellium.

EPA. 2011. *Annual greenhouse gas emissions from passenger vehicles of 4.75 tCO₂ eg. U.S. Environmental Protection Agency (2011)*. "[Greenhouse Gas Equivalencies Calculator](#)."

<http://www.epa.gov/cleanenergy/energy-resources/calculator.html>

Kema, 2012. [Xcel Energy Minnesota DSM Market Potential Assessment Final Report](#) – Volume 1. Accessed online July 31, 2015.

<https://www.xcelenergy.com/staticfiles/xcel/Regulatory/Regulatory%20PDFs/MN-DSM/MN-DSM-Market-Potential-Assessment-Vol-1.pdf>

Lutron. 2010. *Case Study | the New York Times Building, New York, NY*. Prepared by Lutron Electronics Co., Inc.

Mocherniak. 2006. *Lighting Technologies Produce Energy Savings*. Published in *Energy & Power Management*, May 2006.

NEMA. 2013. *Lighting Controls Terminology prepared by NEMA Lighting Controls Section*. Published by the National Electrical Manufacturers Association, January 2013.

NIST. 1995. *NIST Handbook 135: Life-Cycle Costing Manual for the Federal Energy Management Program*. US Department of Commerce National Institute of Standards and Technology, Prepared for the US Department of Energy.

Wei. 2012. *Responsive Lighting Solutions*. Prepared for the General Services Administration.

Williams. 2012. "Lighting Controls in Commercial Buildings," by Williams, A., Atkinson, B., Garbesi, K., Page, E., and Rubinstein, F. *Leukos*, Vol. 8, No. 3, January 2012, pg. 161-180.

Appendix A: Occupant Survey and Results

Occupant Questionnaire

Building / company name:

Room number / floor number / location:

What is your age?

- 30 or under
- 31-40
- 41-50
- Over 50

What is your gender?

- Female
- Male

Is your workspace within 15 feet of a window?

- Yes
- No

Do you have any of the following controls over the lighting in your workspace?

(check all that apply)

- Manual switch
- Manual dimmer
- Window blinds or shades
- Desk (task) lamp
- None of the above
- Other: _____

Please rank your level of satisfaction with the amount of light in your workspace:

1 (very satisfied) 2 3 4 5 6 7 (very dissatisfied)

Please rank your level of satisfaction with the visual comfort of the lighting (glare, reflections, contrast)?

1 (very satisfied) 2 3 4 5 6 7 (very dissatisfied)

Please rank the lighting quality's ability to enhance or interfere with your ability to do your work:

1 (enhance) 2 3 4 5 6 7 (interfere)

| ID | Responder ID | Before Tuning | | | | | | After Tuning | | | | | | | |
|---------|--------------|---------------|--------|-----------------------|---|-----------------|----------------|--------------------|-------------|--------|-----------------------|---|-----------------|----------------|--------------------|
| | | Age | Gender | Workspace Near Window | Lighting Controls | Amount of Light | Visual Comfort | Ability to do Work | Age | Gender | Workspace Near Window | Lighting Controls | Amount of Light | Visual Comfort | Ability to do Work |
| O Off 1 | 1 | Over 50 | Male | Yes | Desk (task) lamp | 2 | 3 | 3 | Over 50 | Male | Yes | Desk (task) lamp | 4 | 4 | 4 |
| O Off 1 | 2 | 31-40 | Male | Yes | Desk (task) lamp | 2 | 2 | 6 | | | | | | | |
| O Off 1 | 3 | 31-40 | Female | Yes | Desk (task) lamp | 7 | 5 | 5 | 31-40 | Female | Yes | Desk (task) lamp | 3 | 5 | 4 |
| O Off 1 | 4 | 31-40 | Female | Yes | Desk (task) lamp | 2 | 1 | 2 | 31-40 | Female | Yes | Desk (task) lamp | 3 | 4 | 4 |
| O Off 1 | 5 | 31-40 | Female | Yes | Desk (task) lamp | 1 | 4 | 4 | 41-50 | Female | Yes | Desk (task) lamp | 2 | 6 | 4 |
| O Off 2 | 1 | Over 50 | Female | No | Desk (task) lamp | 2 | 1 | 2 | | | | | | | |
| O Off 2 | 2 | Over 50 | Male | Yes | Desk (task) lamp | 4.5 | 4.5 | 6 | | | | | | | |
| O Off 2 | 3 | Over 50 | Female | Yes | Manual switch, Window blinds or shades | 2 | 2 | 4 | | | | | | | |
| O Off 2 | 4 | 41-50 | Female | Yes | Manual switch, Window blinds or shades | 4 | 2 | 2 | | | | | | | |
| Comp 3 | 1 | 41-50 | Female | Yes | None of the above | 1 | 1 | 4 | | | | | | | |
| O Off 3 | 1 | Over 50 | Female | Yes | Manual switch, manual dimmer | 1 | 1 | 4 | | | | | | | |
| O Off 3 | 2 | 41-50 | Female | Yes | Desk (task) lamp | 1 | 1 | 4 | | | | | | | |
| O Off 3 | 3 | 41-50 | Female | Yes | Manual switch, occupancy sensors | 3 | 2 | 4 | | | | | | | |
| O Off 3 | 4 | 41-50 | Female | No | Manual switch, occupancy sensors | 3 | 2 | 4 | | | | | | | |
| Bar | 1 | 41-50 | Male | No | Manual switch | 5 | 5 | 3 | | | | | | | |
| O Off 4 | 1 | Over 50 | Male | Yes | Manual switch, Window blinds or shades, Desk (task) lamp | 1 | 3 | 2 | Over 50 | Male | Yes | Manual switch, Window blinds or shades, Desk (task) lamp | 1 | 3 | 2 |
| O Off 4 | 2 | 30 or under | Female | No | Manual switch, Window blinds or shades, Desk (task) lamp | 1 | 2 | 3 | 30 or under | Female | No | Manual switch, Window blinds or shades, Desk (task) lamp | 2 | 3 | 4 |
| O Off 4 | 3 | Over 50 | Male | No | Manual switch, Window blinds or shades, Desk (task) lamp | 1 | 1 | 1 | Over 50 | Male | No | Manual switch, Window blinds or shades, Desk (task) lamp | 1 | 1 | 2 |
| O Off 4 | 4 | Over 50 | Male | Yes | Manual switch, Window blinds or shades, Desk (task) lamp | 1 | 4 | 4 | Over 50 | Male | No | Manual switch, Window blinds or shades, Desk (task) lamp | 1 | 1 | 1 |
| O Off 4 | 5 | 41-50 | Male | No | Manual switch, Window blinds or shades, Desk (task) lamp | 2 | 1 | 2 | 41-50 | Male | No | Manual switch, Window blinds or shades, Desk (task) lamp | 3 | 3 | 4 |
| O Off 4 | 6 | 41-50 | Male | No | Manual switch, Window blinds or shades, Desk (task) lamp | 2 | 1 | 3 | | | | | | | |
| Trans | 1 | Over 50 | Male | Yes | Manual switch, manual dimmer | 2 | 2 | 4 | | | | | | | |
| P Off | 1 | over 50 | Female | Yes | Manual switch, Windows blinds or shades, Desk (task) lamp | 2 | 2 | 2 | over 50 | Female | Yes | Manual switch, Windows blinds or shades, Desk (task) lamp | 2 | 3 | 2 |

Appendix B: Task Tuning Checklist

Site/Space Name: _____

Date: _____

Before the Visit

- Building address, contact name, cell phone number of building contact
- Obtain and review relevant building drawings (hardcopy or electronic)
- Familiarize yourself with the lighting system's controls by reviewing electronic documentation. Identify the steps necessary to adjust the system's high end trim and photosensor setpoint.
- Ask building contact to have lighting controls interface device available (i.e. handheld device or laptop)

During the Visit

- Identify the space or spaces to be task tuned.
 - Task tuning of a space involves understanding how fixtures are controlled and which fixtures are grouped together. Generally, a zone is identified as a group of fixtures that have the same controls (i.e. an entire conference room with modifiable scenes, the portion of an open office controlled by a photosensor)
 - The light levels in every single space in a building should not be measured. Instead, the light levels in a sample of representative spaces should be measured. The calculated reduction in light levels should then be applied to all similar spaces.
- Hand out pre-adjustment occupant surveys (ideally done prior to visit if possible)
- Analyze results of occupant survey. If there is a high level of dissatisfaction with the light levels in the space, consider adjusting approach accordingly. i.e. not task tuning a particular space, or not task tuning a particular space as aggressively.
- Fill out miscellaneous information below

Miscellaneous Information

| | |
|--------------------------------------|--|
| Lighting | |
| Sky Condition | |
| Time of Day | |
| Space Type | |
| Predominant Visual Task | |
| Approximate Average Age of Occupants | |

Measure Untuned Critical Illuminance

- “Lights Off” reading not necessary if no daylight is present (i.e. nighttime, interior space, or able to draw blinds).
 - Take “Lights On” followed by “Lights Off” readings at a given location as quickly as possible as daylight (if present) may change light levels within the space.
 - Allow sufficient time between locations to allow light levels to stabilize after making any control changes.
 - When taking handheld readings, hold sensor away from body to prevent shadowing on lens.
 - Having more than one person is very helpful in accurately recording measurements.
- Select critical workplane.
- The critical workplane is the area where the predominant visual task within a space will likely be performed that also receives the least amount of light. Typically, this is a desktop away from windows and luminaires.
 - Avoid task lights and direct fixture illuminance when selecting the critical workplane.
- Place handheld light meter at the critical workplane.
- Close blinds or shades if possible to minimize daylight
- If task tuning is done at night, this step is not needed.
- Turn on lights. Use lighting controls interface device (i.e. handheld, laptop or wall switch) to bring lights to their maximum power state. Alternately, you can cover the photosensor, if present, to trick the system into bringing the lights on to their full power. Record “Lights On” case in the table below.
- Turn off lights. Record “Lights Off” case in the table below.
- Calculate “Untuned Critical Illuminance” by taking the difference between the “Lights On” and “Lights Off” case.

| Location | “Lights On” Illuminance (fc) | “Lights Off” Illuminance (fc) | Untuned Critical Illuminance (fc) |
|--------------------|---------------------------------|----------------------------------|--------------------------------------|
| critical workplane | | | |

Measure Untuned Average Illuminance

- Close blinds or shades if possible to minimize daylight
 - If task tuning is done at night, this step is not needed.
- Select appropriate Room & Luminaire Type (refer to IES Lighting Handbook (DiLaura 2011) for more detail).
- Record the selected Room & Luminaire Type in the table below. Make note of any orientation details.

| | |
|----------------------------------|--------------------------------------|
| Room & Luminaire Type | |
| Points Orientation Notes | <i>i.e. p-1 is closest to window</i> |

- Hold handheld light meter at one of the locations applicable for your selected Room & Luminaire Type.
- Turn on lights. Use lighting controls interface device (i.e. handheld, laptop or wall switch) to bring lights to their maximum power state. Alternately, you can cover the photosensor, if present, to trick the system into bringing the lights on to their full power. Record “Lights On” case in the table below.
- Turn off lights. Record “Lights Off” case in the table below.
- Repeat process at each applicable location for your selected Room & Luminaire Type.
- Calculate “Untuned Electric Illuminance” by taking the difference between the “Lights On” and “Lights Off” case for each location.

| Location (i.e. q-1, q-2...) | “Lights On” Illuminance (fc) | “Lights Off” Illuminance (fc) | Untuned Electric Illuminance (fc) |
|--------------------------------|---------------------------------|----------------------------------|--------------------------------------|
| | | | |
| | | | |
| | | | |
| | | | |
| | | | |
| | | | |

- Using the appropriate equation (refer to IES Lighting Handbook (DiLaura 2011) for more detail), calculate the Untuned Average Illuminance. When performing this calculation, use the Untuned Electric Illuminance column.

| | |
|---|--|
| Untuned Average Illuminance (fc) | |
|---|--|

Calculate Tuned Critical Illuminance

- Refer to IESNA Lighting Handbook (DiLaura 2011) to determine IESNA Target Illuminance based on space type, predominant visual task occurring in the space and average age of space occupants and record in the table below.

- Calculate Tuned Critical Illuminance using the following formula and enter it in the table below.

$$\text{Tuned Critical Illuminance} = \text{Untuned Critical Illuminance} \left(\frac{\text{IESNA Target Illuminance}}{\text{Untuned Average Illuminance}} \right)$$

- Calculate Percent Reduction using the following formula and enter it in the table below.

$$\text{Percent Reduction} = \frac{\text{Untuned Critical Illuminance} - \text{Tuned Critical Illuminance}}{\text{Untuned Critical Illuminance}}$$

| Name | Value |
|----------------------------|-------|
| IESNA Target Illuminance | |
| Tuned Critical Illuminance | |
| Percent Reduction | |

Implement Task Tuning

- Select specific task tuning scenario that is most appropriate for your space.
- A: Spaces without daylight
 - B: Spaces with daylight, blinds and photosensor
 - C: Spaces with daylight, blinds and no photosensor
 - D: Spaces with daylight, no blinds and photosensor
 - E: Spaces with daylight, no blinds and no photosensor
- Review and become familiar with the steps of the selected task tuning scenario outlined below.
- Record initial lighting control settings below.

| Lighting | |
|--------------------------------------|--|
| Lighting Controls Information | <p>URL:</p> <p>Username:</p> <p>Password:</p> <p>Initial Settings:</p> |

- Place handheld light meter at the critical workplane.
- Follow the steps of the applicable task tuning scenario below.

A: Spaces without daylight

- This scenario is the most straightforward, as it is not complicated by daylight or photosensor control.
- Adjust the high end trim until the measured illuminance at the critical workplane matches the Tuned Critical Illuminance.
- Optional: Ask occupant to perform applicable visual task (i.e. reading small print or computer screen). Ask if light levels cause any visual discomfort.
 - If No, consider decreasing light levels another 5 fc (confirmed by light meter). Only if occupant surveys show a high satisfaction with light levels and facility manager has high level of ownership with space (i.e. can quickly respond to future occupant complaints). Record updated Tuned Critical Illuminance below.
 - If Yes, increase light levels in 5 fc increments (confirmed by light meter) until occupant no longer experiences visual discomfort. Record updated Tuned Critical Illuminance below
- Record final lighting control settings below.

| | |
|---|--|
| Updated Tuned Critical Illuminance (if applicable) | |
| Final Lighting Controls Settings (if applicable) | |

B: Spaces with daylight, blinds and photosensor

- This scenario is more complex. However, you are able confirm that the space has been tuned appropriately as you can reduce the available daylight sufficiently.
- Close any blinds, thereby significantly decreasing the amount of daylight.
- Adjust the photosensor setpoint until the measured illuminance at the critical workplane matches the Tuned Critical Illuminance.
- Optional: Ask occupant to perform applicable visual task (i.e. reading small print or computer screen). Ask if light levels cause any visual discomfort.
 - If No, consider decreasing light levels another 5 fc (confirmed by light meter). Only if occupant surveys show a high satisfaction with light levels and facility manager has high level of ownership with space (i.e. can quickly respond to future occupant complaints). Record updated Tuned Critical Illuminance below.
 - If Yes, increase light levels in 5 fc increments (confirmed by light meter) until occupant no longer experiences visual discomfort. Record updated Tuned Critical Illuminance below.
- If lighting controls require separate high end trim adjustment, in addition to photosensor setpoint adjustment.
 - Verify blinds are closed.
 - Turn off lights.
 - Measure the illuminance at critical workplane. This value defines the Ambient Natural Illuminance. Record below.
 - Calculate the Total Critical Illuminance below. The Total Critical Illuminance is the sum of the Ambient Natural Illuminance and the Tuned Critical Illuminance.

| | | | | |
|-----------------------------------|---|------------------------------------|---|-----------------------------------|
| Tuned Critical Illuminance | | Ambient Natural Illuminance | | Total Critical Illuminance |
| | + | | = | |

- Turn on lights
- Adjust the high end trim until the measured illuminance at the critical workplane matches the Total Critical Illuminance.
- In order to confirm that this adjustment did not affect your photosensor setpoint adjustment, exit controls programming mode. Confirm that light meter still matches Tuned Critical Illuminance
- Open blinds.
- Record final lighting control settings below.

| | |
|---|--|
| Updated Tuned Critical Illuminance (if applicable) | |
| Final Lighting Controls Settings (if applicable) | |

C: Spaces with daylight, blinds and no photosensor

- This scenario is more complex. However, you are able confirm that the space has been tuned appropriately as you can reduce the available daylight sufficiently.
- Close any blinds, thereby significantly decreasing the amount of daylight.
- Turn off lights.
- Measure the illuminance at the critical workplane. This defines the Ambient Natural Illuminance. Record below.
- Calculate the Total Critical Illuminance below. The Total Critical Illuminance is the sum of the Ambient Natural Illuminance and the Tuned Critical Illuminance.

| | | | | |
|-----------------------------------|----------|------------------------------------|----------|-----------------------------------|
| Tuned Critical Illuminance | | Ambient Natural Illuminance | | Total Critical Illuminance |
| | + | | = | |

- Turn on lights
- Adjust the high end trim until the measured illuminance at the critical workplane matches the Total Critical Illuminance.
- Optional: Ask occupant to perform applicable visual task (i.e. reading small print or computer screen). Ask if light levels cause any visual discomfort.
 - If No, consider decreasing light levels another 5 fc (confirmed by light meter). Only if occupant surveys show a high satisfaction with light levels and facility manager has high level of ownership with space (i.e. can quickly respond to future occupant complaints). Record updated Tuned Critical Illuminance below.
 - If Yes, increase light levels in 5 fc increments (confirmed by light meter) until occupant no longer experiences visual discomfort. Record updated Tuned Critical Illuminance below.
- Open blinds.
- Record final lighting control settings below.

| | |
|---|--|
| Updated Tuned Critical Illuminance (if applicable) | |
| Final Lighting Controls Settings (if applicable) | |

D: Spaces with daylight, no blinds and photosenor

- In this scenario, you are unable to confirm that the space has been tuned appropriately as you cannot reduce the available daylight sufficiently. Also, you cannot confirm that the tuned light levels do not cause visual discomfort. Consider revisiting this space at night if possible.

Access lighting control system and find Untuned Photosensor Setpoint. Record below.

Calculated Tuned Photosensor Setpoint. Record below.

$$\text{Tuned Photosensor Setpoint} = \text{Untuned Photosensor Setpoint} * \text{Percent Reduction}$$

| Name | Value |
|------------------------------|-------|
| Untuned Photosensor Setpoint | |
| Tuned Photosensor Setpoint | |

In lighting control system, adjust photosensor setpoint to be equal to calculated Tuned Photosensor Setpoint.

If lighting controls require separate high end trim adjustment, in addition to photosensor setpoint adjustment, access lighting control system and find Untuned High End Trim. Record below.

Calculate Tuned High End Trim. Record below.

$$\text{Tuned High End Trim} = \text{Untuned High End Trim} * \text{Percent Reduction}$$

| Name | Value |
|-----------------------|-------|
| Untuned High End Trim | |
| Tuned High End Trim | |

In lighting control system, adjust high end trim to be equal to calculated Tuned High End Trim.

Record final lighting control settings below.

| | |
|---|--|
| Final Lighting Controls Settings (if applicable) | |
|---|--|

E: Spaces with daylight, no blinds and no photosenor

- In this scenario, you are unable to confirm that the space has been tuned appropriately as you cannot reduce the available daylight sufficiently. Also, you cannot confirm that the tuned light levels do not cause visual discomfort. Consider revisiting this space at night if possible.
- Turn off lights.
 - Measure the illuminance at the critical workplane. This defines the Ambient Natural Illuminance. Record below.
 - Calculate the Total Critical Illuminance below. The Total Critical Illuminance is the sum of the Ambient Natural Illuminance and the Tuned Critical Illuminance.

| | | | | |
|-----------------------------------|----------|------------------------------------|----------|-----------------------------------|
| Tuned Critical Illuminance | | Ambient Natural Illuminance | | Total Critical Illuminance |
| | + | | = | |

- Turn on lights
- Adjust the high end trim until the measured illuminance at the critical workplane matches the Total Critical Illuminance.
- Record final lighting control settings below.

| | |
|---|--|
| Final Lighting Controls Settings (if applicable) | |
|---|--|

After the Visit

- Ask facility manager to re-administer occupant surveys several weeks after task tuning was completed.
- Compile results of occupant survey.
- If surveys show high levels of occupant discomfort, consider retuning space with higher target illuminance levels.

Appendix C: Building specific lessons learned

| Building | Building type | Issue/Suggestion |
|----------------|-----------------|--|
| Building A | Office | Kept one incandescent in some spaces so occupants didn't see flicker. |
| Building B & C | Public Assembly | <p>Even with the lighting controls manual and experienced personnel, it was difficult to figure out how to tune. Took over an hour the first time. However, it was much easier the second time and every time after that.</p> <p>Couldn't reduce lighting power lower than 12% because it resulted in flicker.</p> <p>Didn't regularly install updates to lighting control system. When they finally updated, resulted in days of update time during which the lights in the building were flashing. This was very disruptive and aggravating. Now they make sure to regularly update system.</p> <p>Reduction in % dimming on handheld device is not proportional to light levels and lighting power/current.</p> |
| Building D | Education | <p>Visual discomfort occurs around dusk when contrast is highest. High partitions at end of space cause problems with light levels and occupancy sensors.</p> <p>Training was thorough, but lacked documentation. Follow-up documentation was lacking. As educated occupants, they knew questions to ask. Would have been less helpful for typical occupant. Had to take a flurry of notes as controls rep, hit buttons on handheld. Not effective means of training.</p> |
| Building E | Office | <p>Too many fixture types; would prefer fewer for easier maintenance.</p> <p>When we dimmed the lights to their minimum when tuning, a few fixtures had trouble striking back on to full. Also caused striation.</p> <p>The dipswitches made it hard to tune to a specific level. We had to guess based on our calculated percent reduction.</p> |
| Building F | Public assembly | Only uplights in open office dimmed. We could have reduced light levels further by tuning. However, we didn't because it caused the ceiling to be unlit, giving the space a cave-like feel. |
| Building G | Public assembly | <p>Facility manager didn't know questions to ask during training. Needed period of time to get to know system, and develop list of questions. Then, training should occur.</p> <p>One batch of dimming ballasts was bad. That is what designers remember. Hard to overcome this perception, even though dimming ballasts are typically fine.</p> <p>Systems with multiple controls (occupancy and master switch) can be confusing to occupants.</p> <p>We tried to reduce light levels to IESNA recommended targets. However, librarians preferred higher light levels. So, we ended up staying with the lighting control manufacturer's 85% trim.</p> |

| Building | Building type | Issue/Suggestion |
|-------------------|-----------------|--|
| Building I | Public Assembly | <p>Dimming is important to save energy and money in well-daylit spaces. However, in other spaces, it allows for flexibility and usability of space.</p> <p>Dimming is better than stepped because it minimizes occupant complaints.</p> <p>Motivated/educated occupants can save just as much energy through manual control of lights as automatic controls.</p> <p>When doing photometrics, had to guess as to reflectivity of open ceiling. Should have been more conservative.</p> <p>People are adaptable, can adjust to different light levels and color temperatures.</p> <p>Selecting a custom ballast factor allows for task tuning without expense of additional controls.</p> <p>Energy savings from tuning can be negated when ballasts are replaced, or replacing high performance lamps with less efficient ones.</p> |
| Building J | Office | <p>Use open loop photosensors to control lighting in well daylit spaces.</p> <p>Given enough time and effort, it is possible to utilize a complex, flexible lighting control system to near its full capability.</p> |
| Building K | Office | <p>Once you have dimming, adding other controls is easy. It's getting dimming in the first place that is the major financial barrier.</p> |
| Building L | Office | <p>Tried to change exterior lighting schedule, ended up altering interior lighting schedule, resulted in lights off during day and on at night. Needed better training, and more granularity with schedules.</p> <p>There was a disconnect between owner's needs and lighting designer's vision.</p> <p>Have a lot of flexibility with scenes in Event Space, but haven't had time to utilize them fully.</p> |
| Building N | Public Assembly | <p>Lots of turnover in building maintenance staff, leads to different ballasts being replaced, different control adjustments, and assorted other problems. This being addressed by development of training and comprehensive maintenance plan.</p> <p>Target illuminance level for fitness areas is between 40 and 45 fc.</p> <p>Have delamped a considerable amount of lamps in many facilities because of overlighting.</p> <p>Manager wouldn't put dimming into other clubs. Their research showed that dimming ballasts have a \$50 to \$75 premium, but can only save between \$5 and \$10.</p> |

| Building | Building type | Issue/Suggestion |
|------------|----------------|--|
| Building O | Office | <p>Stepped daylight controls led to frequent on/off cycles. Photosensor location was not optimal, was getting feedback from electric lights.</p> <p>Improving controls is difficult to finance. Need municipal bond and board approval.</p> <p>Remote access to system is nice for flexibility. However, there needs to be a means to log changes. Controls manufacturer made a change remotely, that accidentally set the timeclock off by 12 hours. Resulted in problems, but no one on-site knew what was happening.</p> <p>Building owners described their system as having dimming. We therefore visited the site. In actuality, the system was stepped dimming. So, we were unable to tune it.</p> |
| Building P | Fitness Center | <p>Building owners described their system as having dimming. We therefore visited the site. In actuality, the system was stepped dimming. So, we were unable to tune it.</p> |